

aspex

---

COMMERCIAL DOORSETS  
Architectural Excellence

DOORSETS | IRONMONGERY | ACCESS CONTROL

---

[www.aspex.co.uk](http://www.aspex.co.uk) | [info@aspex.co.uk](mailto:info@aspex.co.uk)

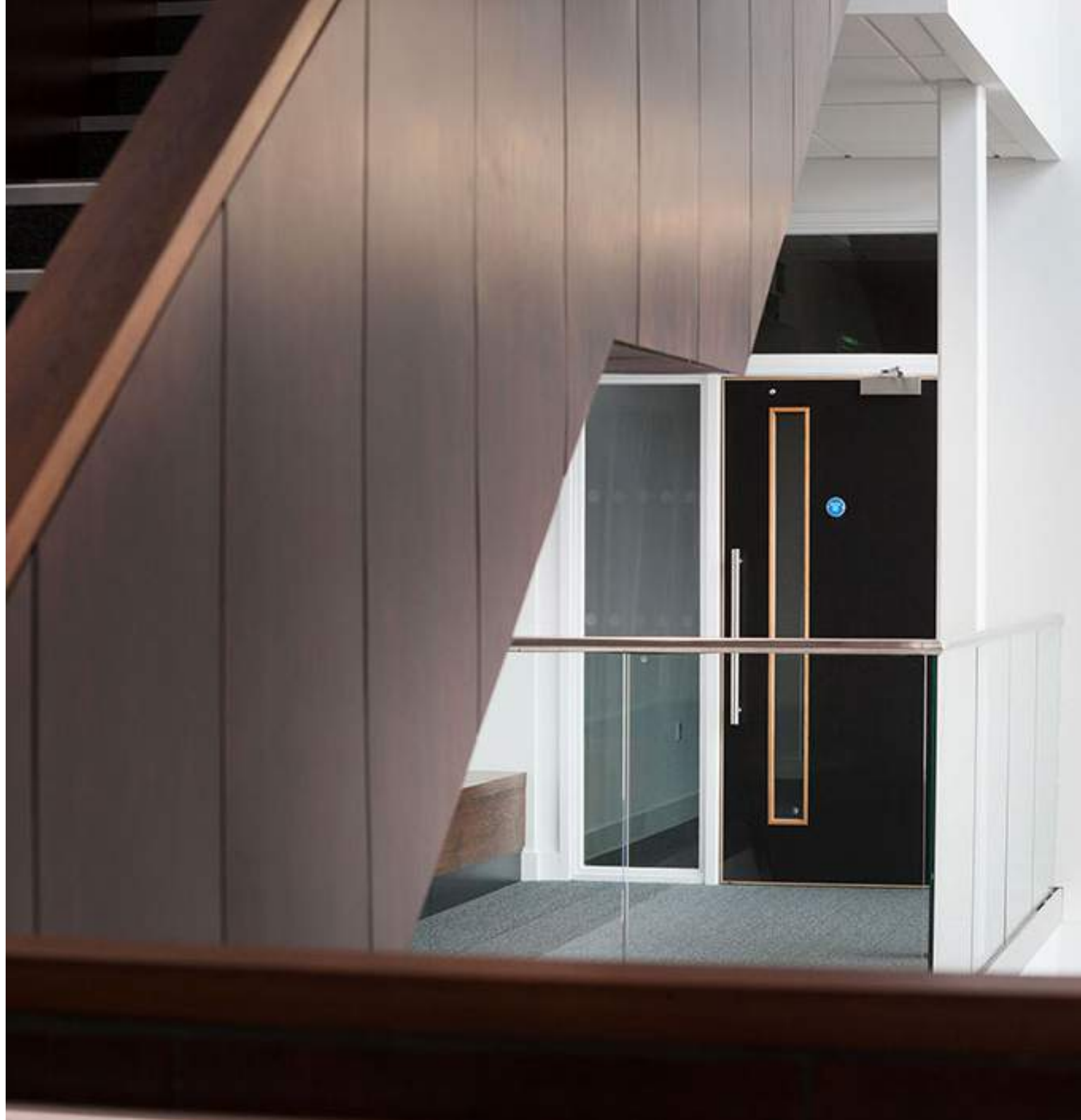

# ABOUT US

## ARCHITECTURAL EXCELLENCE

Aspex began as a dedicated ironmongery business in 2006, and we have since expanded our product range with doorsets, risers and access control to offer the complete interior fitout solution.

We introduced timber doorsets supply in 2012, began manufacturing doorsets in 2019 and now we have extended our factory by 40,000 sq ft to increase the production capacity and also to bring the production of technical door leaves in-house.

Our experienced project consultants can help you make well-informed decisions about any project from residential, accommodation, education, healthcare and commercial. We can help propose suitable doorset choices from door cores, configurations and finishes making sure the proposed options adhere with the required fire performance, regulatory compliance, budget, delivery timeframes and interior design visions. Our aim is to support you every step of the way, not just supply doorsets.

Speak to our team about design choices, industry standard or bespoke options, estimating & scheduling, sampling, optimised delivery plans and maintenance tips and more.

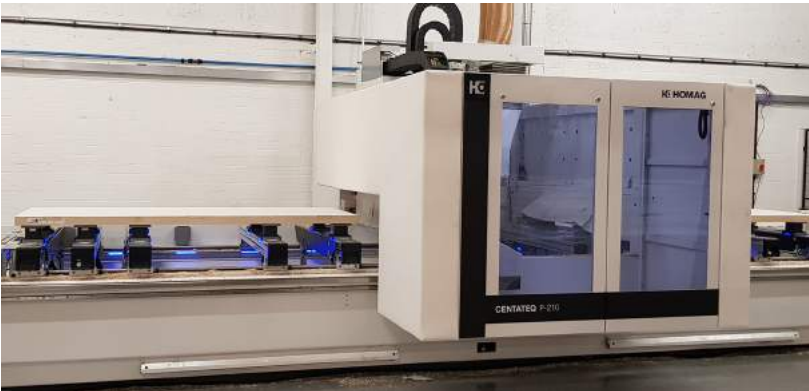

### 2006

Established in 2006, Aspex was founded on a long-established family history of success, dedication and innovation within the architectural ironmongery industry.

### 2010

Introduced access control and integrated systems division. Aspex are Platinum Inspired Business Partners of Salto and work closely with many other manufacturers to secure your premises

### 2012

Introduced supplying timber doorsets working closely with carefully selected door manufacturers

### 2016

Introduced Novista concealed doorsets, pocket sliding doors and risers

### 2019

Introduced manufacturing of timber doorsets in-house

### 2023

Extending factory by 40,000sqft to increase capacity and to bring the production of technical door leaves in-house.

Separate division formed for the manufacture and supply of doorsets for the education, healthcare and commercial sectors

## COMMERCIAL

Offices, retail shopping centres, public transport, train stations, police stations

### PERFORMANCE

Fire Rating - Ranging from FD30 up to FD120 in align with IFC Certification

PAS24:2016 Security Rated

Acoustic Rating up to 48dB Rw

Severe duty

Tested to BS EN 1192/DD171 classified as grade 4 severe duty & tested to BS EN 1191

### DESIGN

Full height doors up to 3m

Over panels

## EDUCATION

Primary and secondary schools, colleges, universities and student accommodations

### PERFORMANCE

Fire Rating - Ranging from FD30 up to FD120 in align with IFC Certification

PAS24:2016 Security Rated

Acoustic Rating up to 40dB Rw

Severe duty

Tested to BS EN 1192/DD171 classified as grade 4 severe duty & tested to BS EN 1191

### FEATURES

Safety and compliance guidance of Department for Education (DfE)

Finger protection mechanisms

## HEALTHCARE

Hospitals, GP health centres, opticians and dentist practices, mental health units

### PERFORMANCE

Fire Rating - Ranging from FD30 up to FD120 in align with IFC Certification

PAS24:2016 Security Rated

Acoustic Rating up to 48dB Rw

Severe duty

Tested to BS EN 1192/DD171 classified as grade 4 severe duty & tested to BS EN 1191

### FEATURES

X Ray Doorsets

Anti Bacterial

Postformed doorsets







HIGH-PERFORMANCE  
**DOORSETS**

# CLASSROOMS, OFFICES, CONSULTING ROOMS

High-quality, durable doorsets available with vision panels and side screens to promote the transition of natural light into internal spaces.

## PERFORMANCE

Fire Rating - Ranging from FD30 up to FD120  
Fire rated and manufactured in accordance with the International Fire Consultants Third Party Certification scheme (IFCC)

Acoustic Rating -  
Rating up to 40dB Rw

Severe Duty -  
Tested to BS EN 1192/DD171 classified as grade 4 severe duty & tested to EN 1191 BM Trada certified

## VISION PANELS

Standard vision panel style details, DDA compliant to BS 8300:2009

- Single narrow vision panel
- Single wide vision panel
- Narrow split vision panels
- Wide split vision panels
- Fully glazed
- Privacy blinds

## CONFIGURATIONS

Single  
Leaf & Half  
Side Screen

## FINISHES

Veneered  
Laminated  
PVC  
Painted

## ACCESS CONTROL

Standalone access controlled (Salto recommended)





# CIRCULATION & PUBLIC SPACES

High performance, durable doorsets designed for high traffic circulation and communal areas

## PERFORMANCE

Fire Rating - NFR or FD30/FD60S Fire rated and manufactured in accordance with the International Fire Consultants Third Party Certification scheme (IFCC)

The pre-hung factory doorset can meet the requirements for clear opening widths within approved Document M

## Severe Duty -

Tested to BS EN 1192/DD171 classified as grade 4 severe duty & tested to EN 1191 BM Trada certified

## DESIGN

- Standard
- Full height
- Vision panels
- Double action

## CONFIGURATIONS

Single  
Double doors  
Leaf & Half  
Side Screen

## FINISHES

Veneered  
Laminated  
PVC  
Painted

## ACCESS CONTROL

Network access controlled (Salto recommended)



# STORE ROOM & CUPBOARDS

Resilient doorsets designed for high-traffic circulation and public spaces with attention to finish for durability, suitable design options for convenience.

## PERFORMANCE

Fire Rating - NFR or FD30/FD60S Fire rated and manufactured in accordance with the International Fire Consultants Third Party Certification scheme (IFCC)

## SPECIFICATION

Manufactured with a solid core

- Door leaf constructed from a severe duty core tested to DD171, with hardwood lippings on all 4 sides
- Standard sizes or bespoke available

## DOOR FINISHES

Veneered  
Laminated  
PVC

## ACCESS CONTROL

Standalone access controlled (Salto recommended)



# NOVISTA STEEL RISERS

## FRAME

Concealed/Picture frame design made from 1.2mm steel. 3 or 4 sided frame options

## LEAF

Double skin 1.0mm Zintec Steel with glass wool insulated core. 48mm thick

## CONFIGURATIONS

Single leaf, double leaf and up to six leaves within one frame

## PERFORMANCE

Fire Rating - FD120(S)

Acoustic Rating - 41dB Rw (as standard)

Smoke/Air tested - To BS6375-1, BSEN1634-3 and to BSEN13501-2

Thermal Resistance - 1.43(m2K)/W

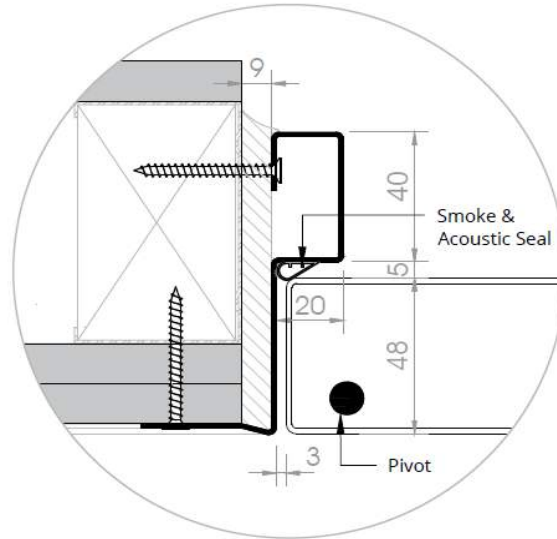

## POPULAR CONFIGURATIONS

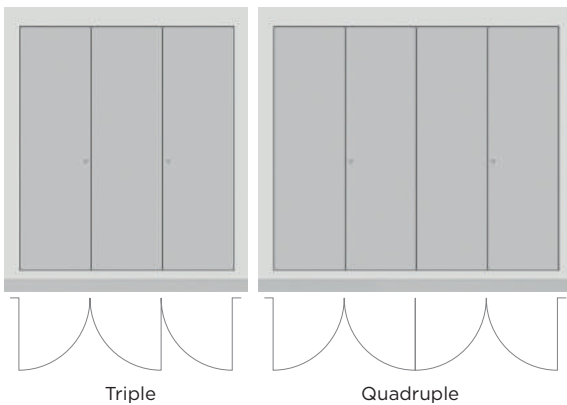

\*More options available





# NOVISTA TIMBER RISERS

## FRAME

Concealed/Picture frame design made from 1.2mm steel. 3 or 4 sided frame options

## LEAF

Solid core to suit application\*

FD30, up to 2500mm high and 800mm wide  
leaves\*FD60, up to 2420mm high and 850mm wide\*

## CONFIGURATIONS

Single leaf & double leaf

## PERFORMANCE

Fire Rating - FD30/60

Acoustic Rating - up to 35dB Rw

Smoke/Air tested - To BS6375-1, BSEN1634-3  
and to BSEN13501-2

Thermal Resistance - Consult technical dept.

## POPULAR CONFIGURATIONS

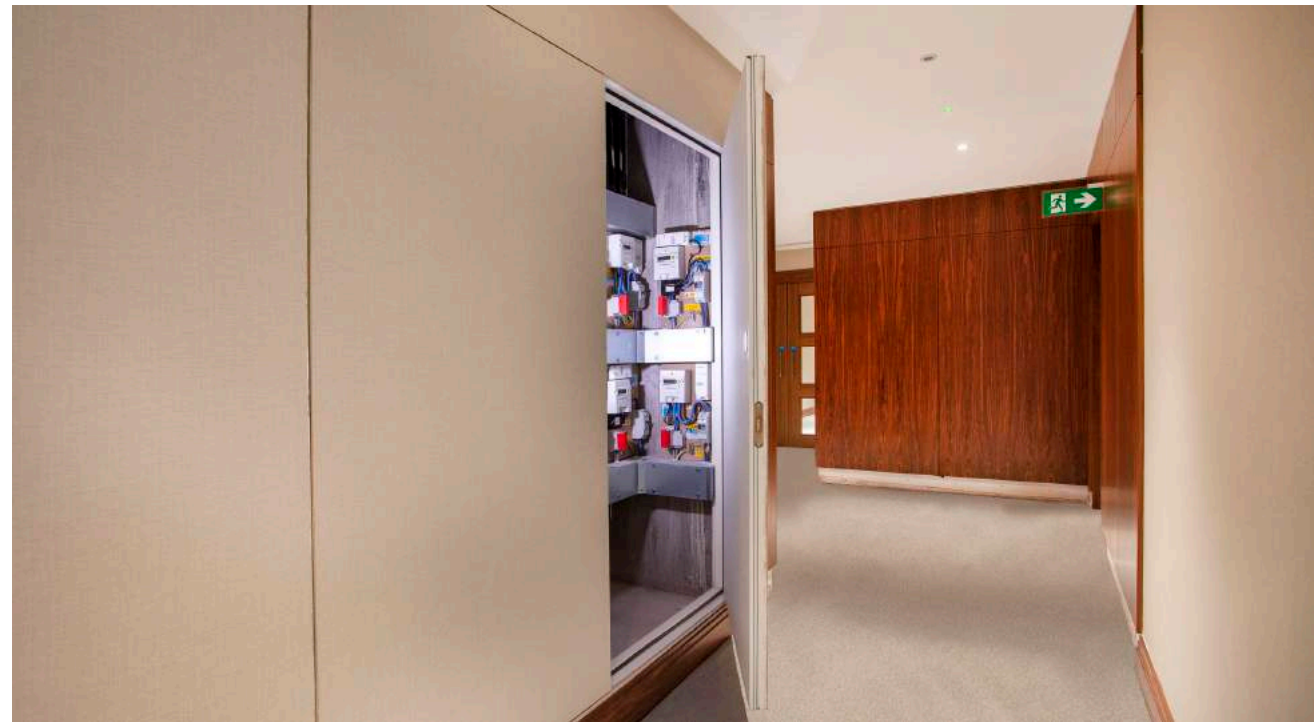
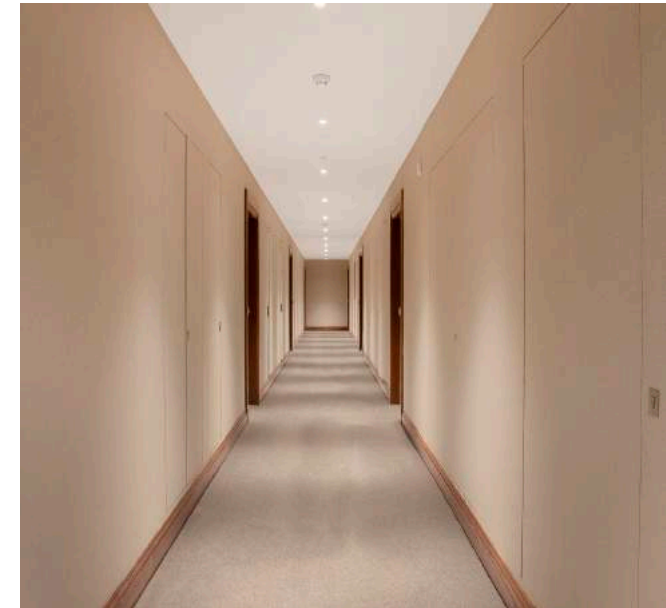
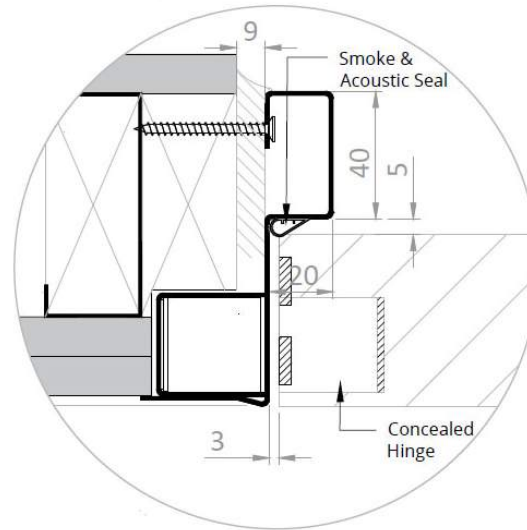
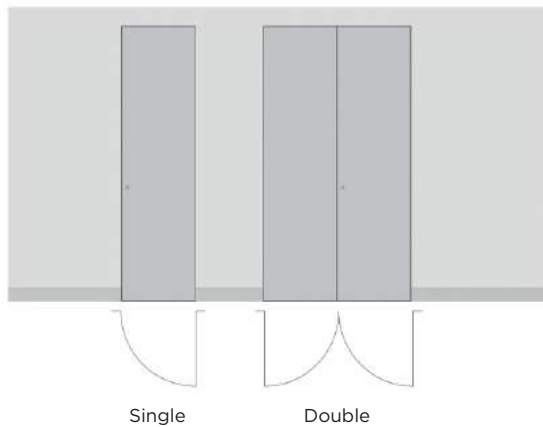

# ACOUSTIC DOORS

This sound-proof door is supplied as a complete doorset. Ideal choice for areas requiring above average levels of sound insulation.

## SPECIFICATION

- High Density GDC or solid timber laminated core
- Manufactured with a solid core, hardwood lipping on 4 sides. The door leaf is available either Laminated, Veneered, Factory Painted or Primed.
- 8mm hardwood lippings to all 4 sides. Lipping edge can match or contrast the face finish
- Overall thickness: 44mm (32dB), 54mm (35dB), 59mm (43dB), 84mm (48dB)
- Bespoke sizes - 930mm max (w), 2330mm max (h)

## PERFORMANCE

- Fire Rating - NFR or up to FD120
- Acoustic Rating - 30dB to 48dB
- Tested to BS EN 1192 / DD171 and classified as grade 4 severe duty
- Manufactured to ISO 9001 standards

## DOOR FINISHES

Veneered  
Laminated  
PVC

## CONFIGURATIONS

Single, double, leaf & half and other choices  
Vision panel options

## ACCESS CONTROL

Standalone access controlled (Salto recommended)



# ACCESS CONTROL COMMUNAL

## SMART SECURITY

### SPECIFICATION

- Access control compatibility with various systems
- Overall thickness 54mm for NFR, FD30 and FD60
- Up to 35dB acoustic rated (with the correct seal arrangement)
- Tested to DD171 and classed as severe duty
- Choice of vision panel design options available

### PERFORMANCE

- PAS24:2016 Security Rated (optional)
- Fire tested to BS 476 part 22
- All fire rated doorsets manufactured in align with IFC Certification scheme
- Doorsets meet requirements of Approved Doc M for clear opening widths

### CONFIGURATION

- Single





# STEEL DOORS (INTERNAL & EXTERNAL)

Quality, secure and certified steel doorsets representing strength and durability, and security features available. Suitable for internal and external use, fits well with residential and commercial spaces.

## INTERNAL

- FD60, FD120, FD240
- Single or double configurations
- Panel options - solid, glazed, louved
- Custom-made in a choice of finishes
- Suitable for Masonry, Concrete and Flexible Stud wall

## EXTERNAL

- General purpose external door
- Single or double configurations
- Variety of colours and finishes available
- Custom sizes available
- Hardware already fitted saving time & effort on site

## SECURITY

- Intruder and blast security doors
- SECUR-DOR2: low to medium protection, suitable for residential
- SECUR-DOR3: medium protection suitable for residential to commercial
- SECUR-DOR4: medium to high protection

## ACCESS CONTROL

Network access controlled (Salto recommended)





DESIGN OPTIONS FOR  
**VISION PANELS**

# VISION PANELS

## MINIMUM ZONES OF VISIBILITY

Many fire doors within education, healthcare and commercial sectors will include at least one vision panel per door leaf. The position of each vision panel must fall within the guidelines highlighted below to ensure of inclusivity where all types of users can benefit from the vision panel.

To ensure your fire doors are compliant with Building Regulations Part M: Mobility, we have provided a few diagrams to support correct design and specification criteria.

Please use these in conjunction with the latest building regulation codes to comply with compliance and relevant standards.

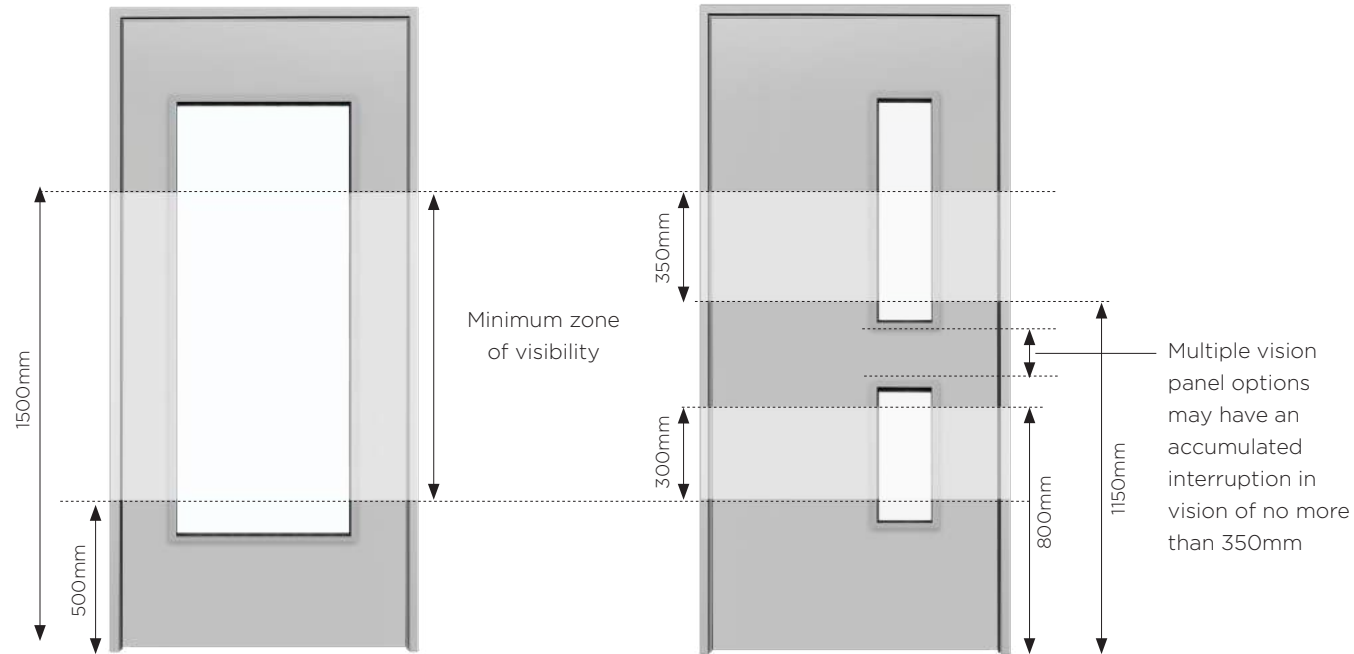



# VISION PANEL OPTIONS

The vision panels shown are our most commonly used designs.

Alternative design options are available, subject to fire certification and minimum aperture margins.

Glazed bead dimensions and seal arrangements will vary depending on fire and acoustic certification.

 In compliant with BS 8300 for wheelchair accessibility

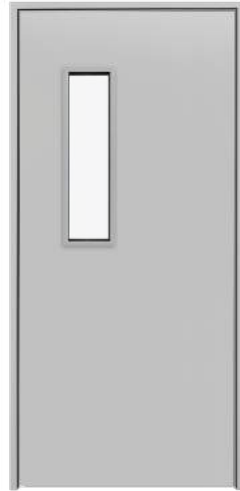

VP-A

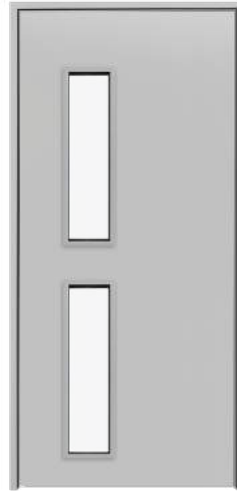

VP-B

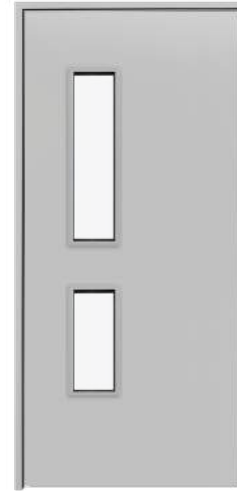

VP-C

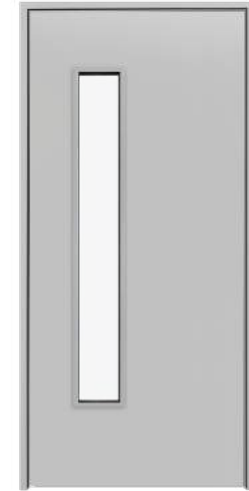

VP-D

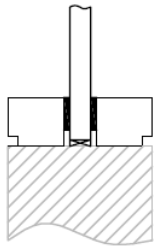

Flush - Hardwood

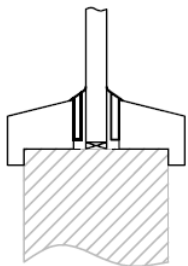

Bolection - Hardwood

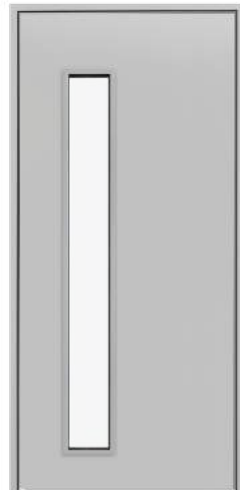

VP-E

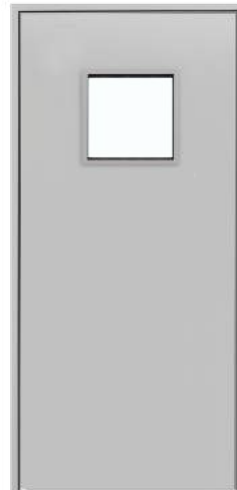

VP-F

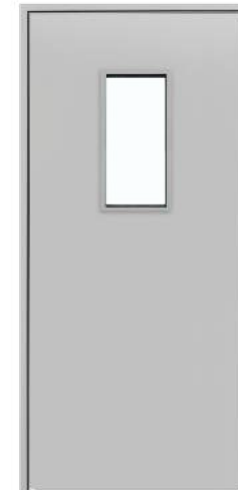

VP-G

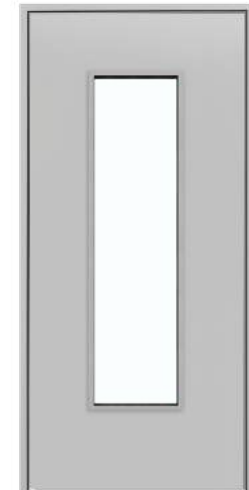

VP-H





CONFIGURATIONS  
& FRAME TYPES

# CONFIGURATIONS

STANDARD CHOICES, BESPOKE AVAILABLE

## SINGLE DOOR CONFIGURATIONS

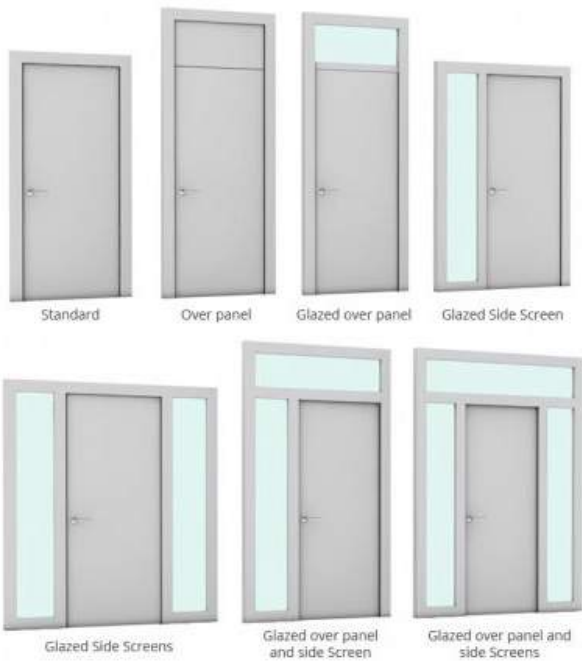

## LEAF & HALF CONFIGURATIONS

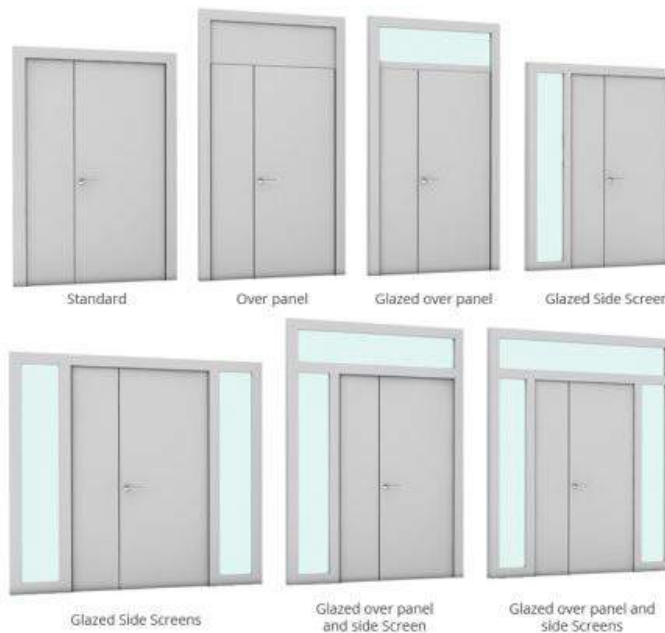

## DOUBLE DOOR CONFIGURATIONS

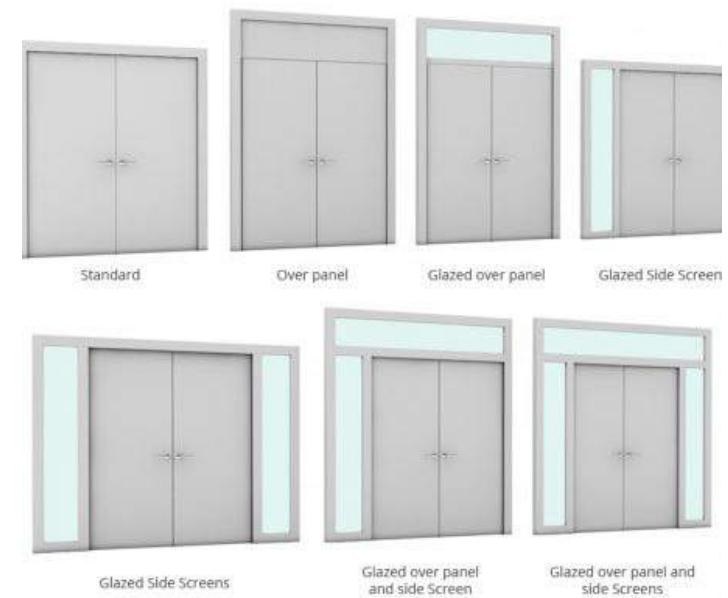

Multiple screen option available, please contact us for more details - [info@aspex.co.uk](mailto:info@aspex.co.uk).



# FRAME TYPES

WITH UNIQUE FEATURES

A wide selection of different door frames can be supplied, manufactured from either MDF, softwood, hardwood, or steel, and each of these materials has its own unique advantages.

Standard lining, and stop or rebated frames, are available, together with specialist types for sports halls or finger protection choices.

FRAME TYPE ONE -  
LINING AND STOP



FRAME TYPE TWO -  
REBATED



FRAME TYPE THREE -  
SPLIT WITH SEPARATE  
ARCHITRAVES



FRAME TYPE FOUR -  
REBATED WITH INTEGRATED  
ARCHITRAVES



FRAME TYPE FIVE -  
DOUBLE SWING





DESIGN FEATURES  
& FINISHES

# PVC

## FINISH OPTION

Choose impact-resistant, highly hygienic PVC surfaces ideal for clean rooms, washrooms and laboratories.

Other colours may be available to suit RAL codes, please contact us for more information.

### GREYS/BLACK

SNOW WHITE TEXTURED  
NEAREST RAL 9001  
LRV 73.85

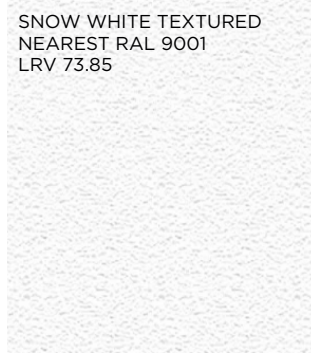

PALE GREY TEXTURED  
NEAREST RAL 7044  
LRV 51.38

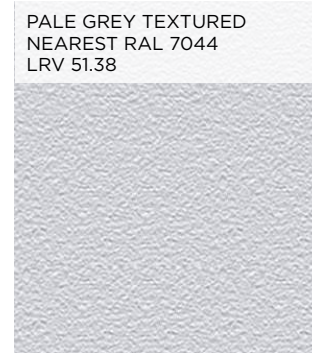

STORM GREY TEXTURED  
NEAREST RAL 7037  
LRV 21.66



BLACK SMOOTH  
NEAREST RAL 9011

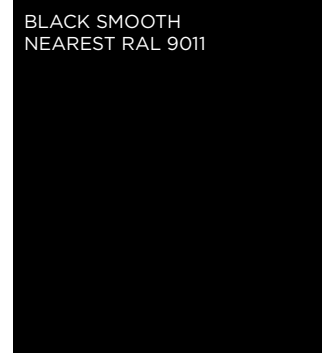

### LIGHT SHADES

IVORY TEXTURED,  
NEAREST RAL 1013.  
LRV 73.85

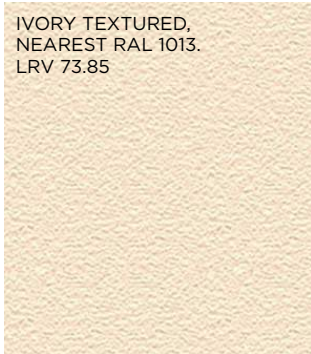

PASTEL GREEN  
SMOOTH  
LRV 70



PASTEL BLUE  
SMOOTH LRV 52

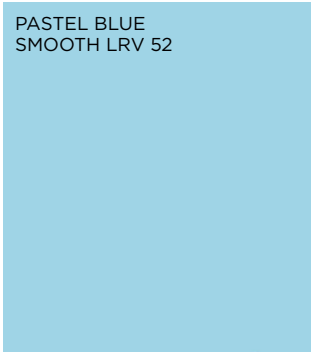

AVOCADO SMOOTH  
LRV 34

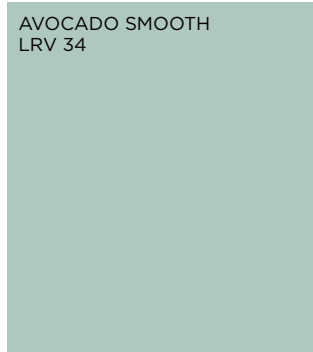

### BRIGHT SHADES

RED SMOOTH  
LRV 3

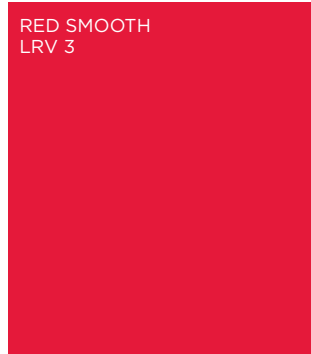

PINK SMOOTH  
LRV 13

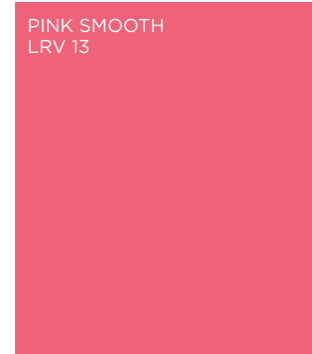

PURPLE SMOOTH  
LRV 9

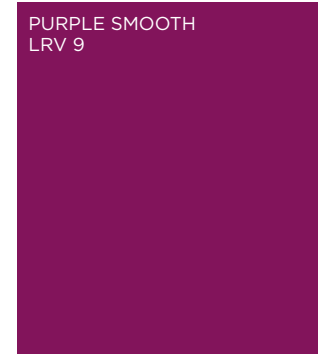

ORANGE SMOOTH  
LRV 26

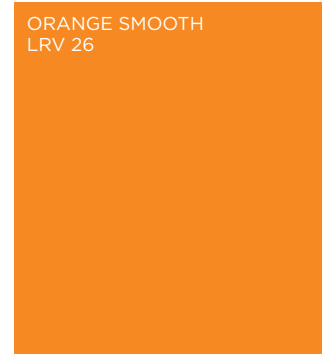

TWILIGHT BLUE TEXTURED  
NEAREST RAL 5003  
LRV 8.25



PALE BLUE TEXTURED  
NEAREST RAL 5024  
LRV 31.03

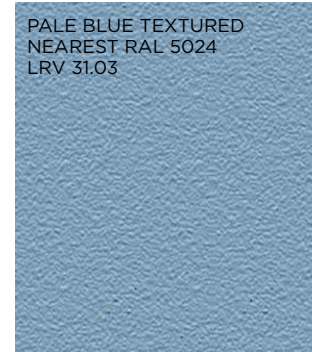

PALE GREEN TEXTURED  
NEAREST RAL 6034  
LRV 37.32



POSEIDON BLUE TEXTURED  
NEAREST RAL 5012  
LRV 27.13

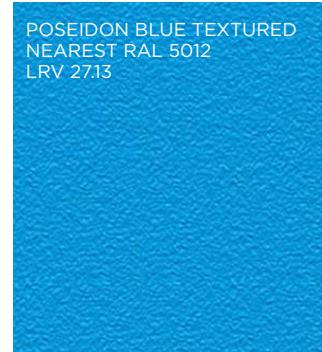



# LAMINATES

## FINISH OPTION

Choose beautiful laminate finishes to enhance your interiors.

Excellent range of colour or wood alike laminates.

We hold an exclusive direct-supply agreement with Formica, and work with Egger and Polyrey too.

\*More options available

## COLOUR LAMINATES

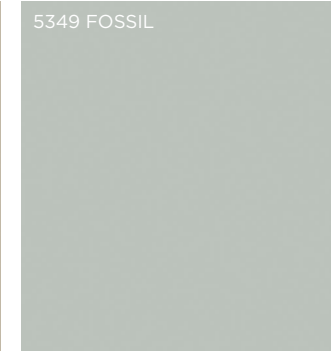
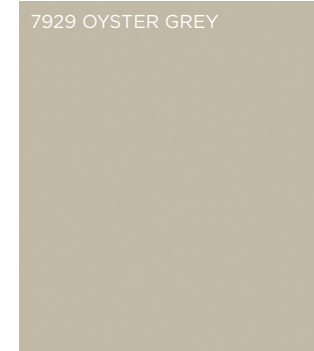
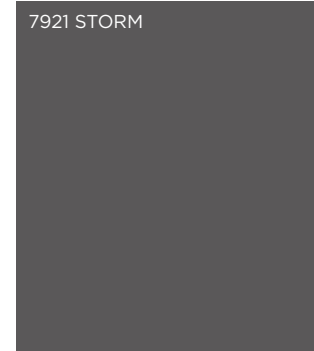
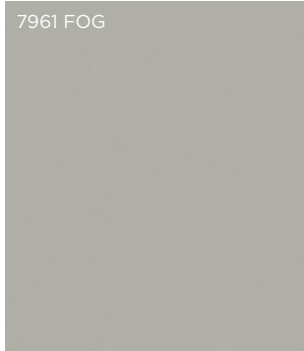

## WOOD LAMINATES

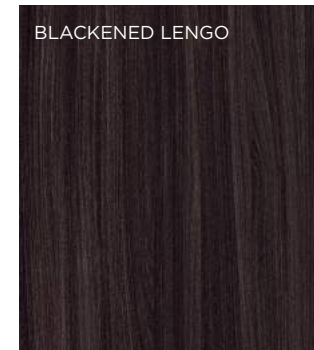
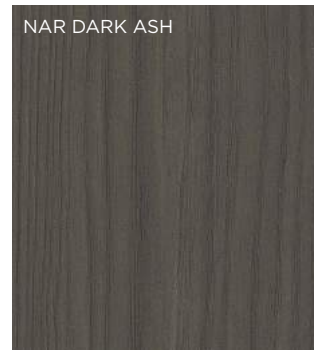
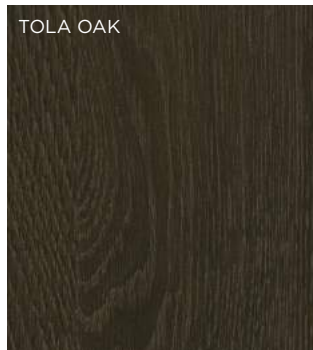
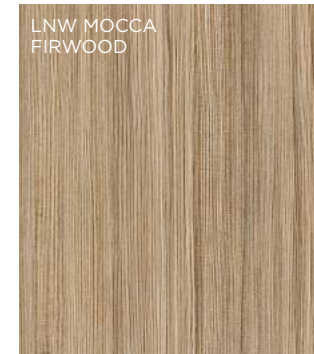

# VENEERS

## FINISH OPTION

Choose luxurious veneers finishes - from natural, dyed, smoked and reconstituted finishes.

\*More options available

### NATURAL/EXOTIC VENEERS

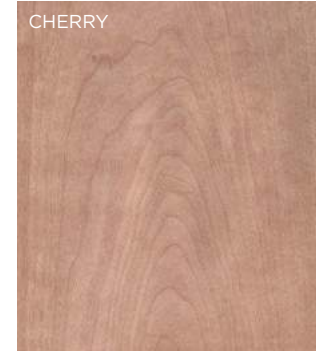

### RECONSTITUTED/SMOKED VENEERS

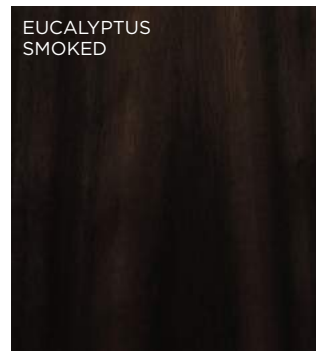

### DYED VENEERS

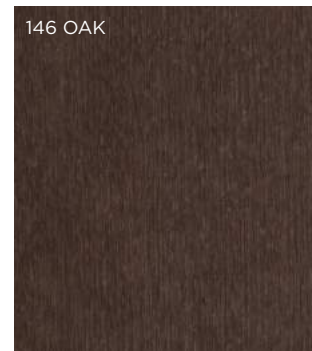
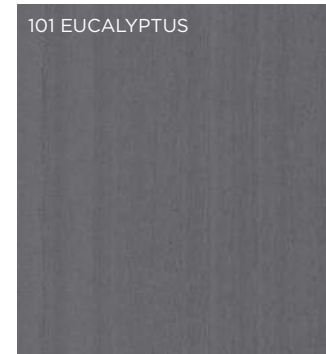
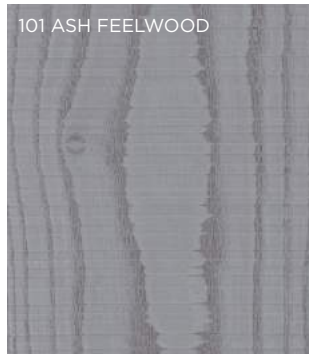

# PAINT

## FINISH OPTION

Choose any RAL colour to closely match your doorset to complement your interior design.

Bespoke colour options available

\*More options available

### BLACKS

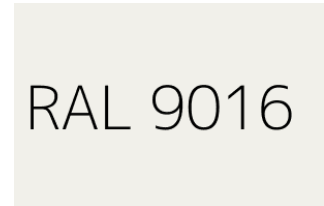
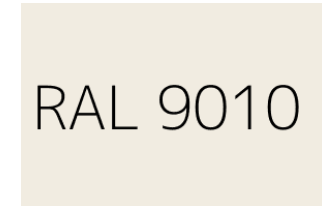
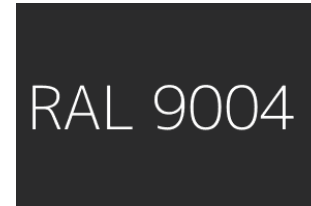
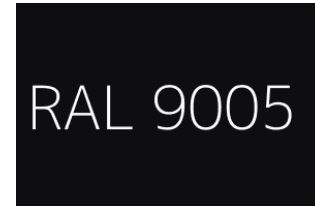

### BROWNS

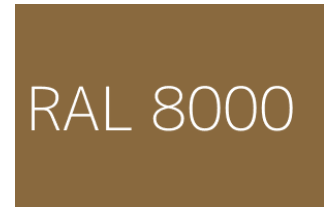
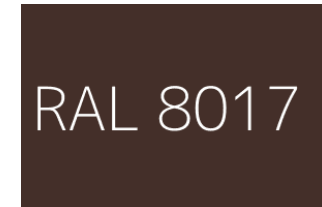
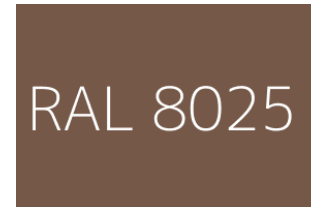
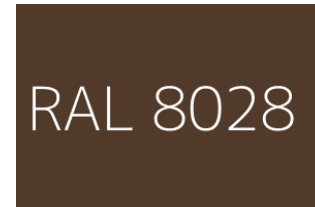

### BLUES

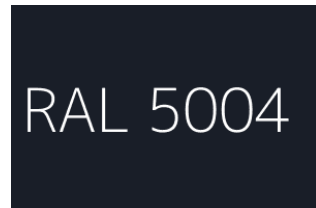

### GREYS

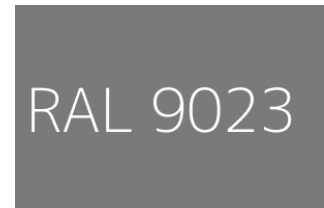
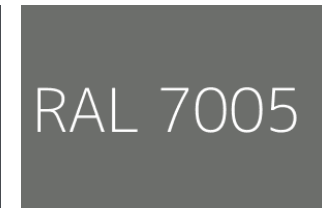
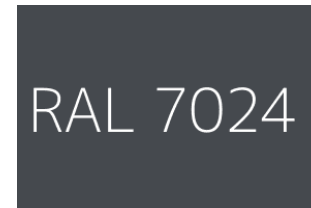
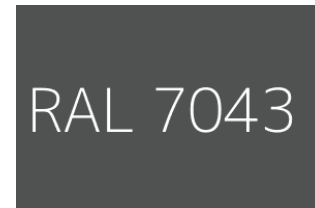

### REDS

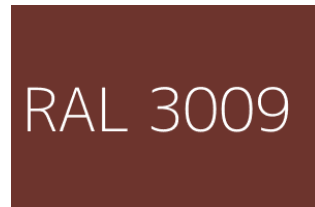
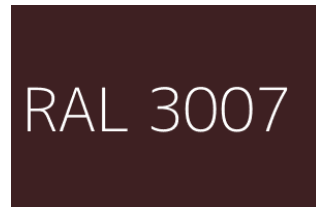

### GREENS

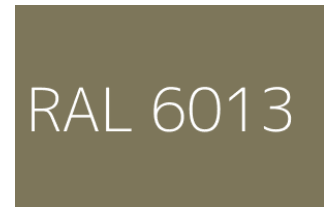
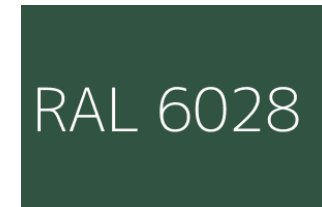
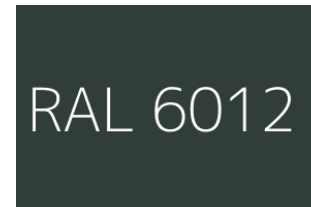
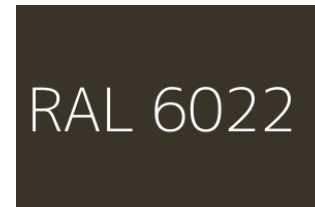



# STYLE INSPIRATION

## DESIGNS

C1 Single Door, Flush



C2 Single Door, VP-D



C3 Single Door, VP-B Split Vision



C4 Single Door with Screen



C5 Leaf & Half, Flush



C6 Double Doors, Flush

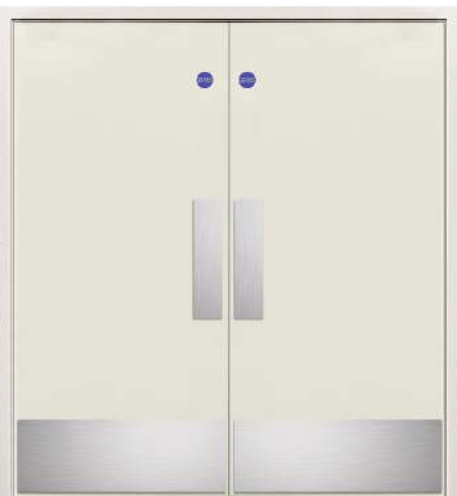

C7 Double Doors, VP-D



C8 Double Doors, VP-B Split Vision



C9 Leaf & Half, VP-D





IRONMONGERY &  
ACCESS CONTROL

# IRONMONGERY

## PURPOSE-LED RANGE

Ultimate solution of architectural ironmongery from...

- ✓ Lever handles
- ✓ Pull handles
- ✓ Escutcheons
- ✓ Turns and releases
- ✓ Hinges
- ✓ Signage
- ✓ Locks & cylinders
- ✓ Door closers
- ✓ Panic Hardware
- ✓ Miscellaneous

Range of finishes...

- ✓ Satin stainless steel
- ✓ Polished stainless steel
- ✓ Aluminium
- ✓ Nylon
- ✓ Black
- ✓ Bronze
- ✓ Brass

### In align with relevant standards...

- CE Marked
- BS 8300
- BS EN
- Certifire



### HEALTHCARE

High-performance, durable and smart ironmongery available in suitable finishes including stainless steel, aluminium, nylon.

Washroom and WC fittings designed for disabled users include stainless steel, nylon and aluminium powder coating.



### EDUCATION

Resilient, quality and innovative ironmongery with finger protection, anti-bacterial and sophisticated features. Most suited stainless steel, aluminium, nylon finishes available. Robust nylon helps add pop of colour and does not chip or flake off. Braille and tactile signage available too.

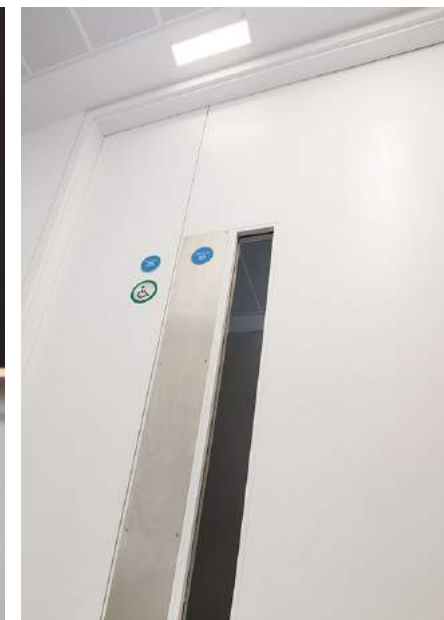

### COMMERCIAL

Quality, functional ironmongery with attractive aesthetics available in a variety of finishes from stainless steel to black, in adherence to relevant standards.



# ACCESS CONTROL

## SMART, INNOVATIVE SOLUTIONS

Aspex are a proud Platinum Inspired Business Partner of Salto offering seamless, relevant and efficient solutions.

As a dedicated solution provider, we offer the complete package from - supply, installation and maintenance support.

We work a range of leading manufacturers...

**SALTO**

**ASSA ABLOY**

**Paxton**

**OMNITEC**

**alhua**  
TECHNOLOGY

**HIKVISION**



### ESCUTCHEONS

XS4 One Escutcheons need no hard-wiring, battery-operated. All-in-one smart lock designed to fit on any door type & retrofits.



### WALL READERS

Smart wall readers integrate with any type of access control application - doors, barriers, lifts, electronic gates etc.



### TURNSTILES

Manage crowd-control, prevent tailgating with smart turnstiles. Integrated with building access control system



### AUTOMATED DOORS

Control of automated doors integrated with access control, fire alarm systems and supporting disability access



### PANIC EXIT BARS

Highest safety standards with ease of use. EN1125 compliant in combination with Salto XS4 electronic escutcheon



### CAR PARK BARRIERS

Seamless integration with existing management systems. ANPR car park barrier, intercom features, keyless access possible



Let's work on specifications together, find us on...



**NBS Chorus**



**NBS Source**  
PARTNER

## FREE SAMPLES

Request for door leaf samples & ironmongery sample board to see how well we can match your project requirements.  
Simply email [sales@aspex.co.uk](mailto:sales@aspex.co.uk)

## GET IN TOUCH

[www.aspex.co.uk](http://www.aspex.co.uk) | [info@aspex.co.uk](mailto:info@aspex.co.uk)  
England office: 0116 278 3506  
Scotland office: 01236 720061

**aspex**