

aspex

COMMERCIAL DOORSETS
Architectural Excellence

DOORSETS | IRONMONGERY | ACCESS CONTROL

www.aspex.co.uk | info@aspex.co.uk

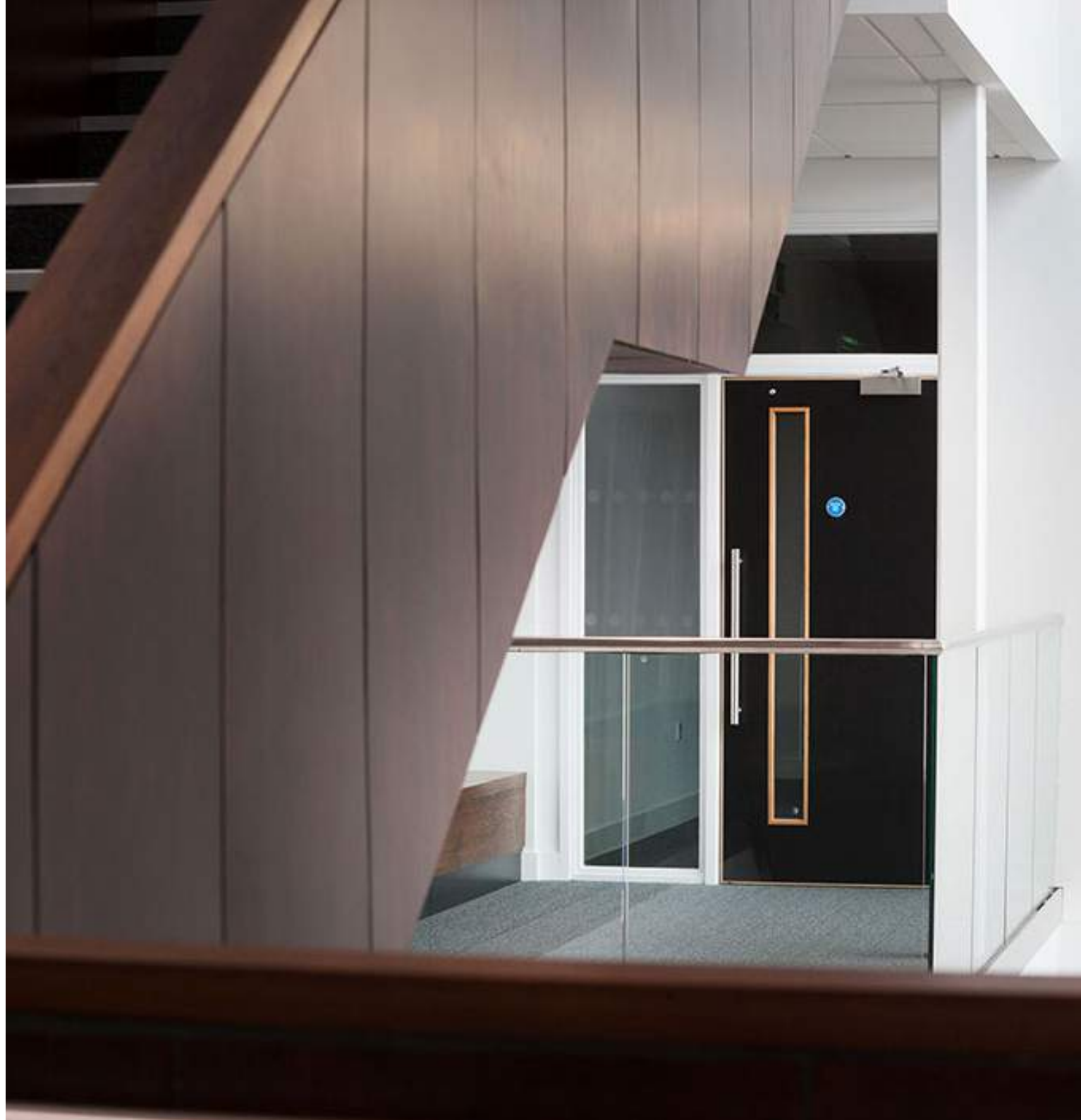

ABOUT US

ARCHITECTURAL EXCELLENCE

Aspex began as a dedicated ironmongery business in 2006, and we have since expanded our product range with doorsets, risers and access control to offer the complete interior fitout solution.

We introduced timber doorsets supply in 2012, began manufacturing doorsets in 2019 and now we have extended our factory by 40,000 sq ft to increase the production capacity and also to bring the production of technical door leaves in-house.

Our experienced project consultants can help you make well-informed decisions about any project from residential, accommodation, education, healthcare and commercial. We can help propose suitable doorset choices from door cores, configurations and finishes making sure the proposed options adhere with the required fire performance, regulatory compliance, budget, delivery timeframes and interior design visions. Our aim is to support you every step of the way, not just supply doorsets.

Speak to our team about design choices, industry standard or bespoke options, estimating & scheduling, sampling, optimised delivery plans and maintenance tips and more.

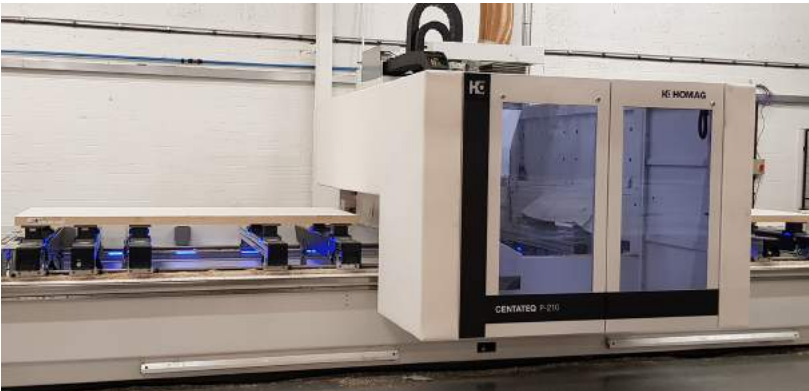

2006

Established in 2006, Aspex was founded on a long-established family history of success, dedication and innovation within the architectural ironmongery industry.

2010

Introduced access control and integrated systems division. Aspex are Platinum Inspired Business Partners of Salto and work closely with many other manufacturers to secure your premises

2012

Introduced supplying timber doorsets working closely with carefully selected door manufacturers

2016

Introduced Novista concealed doorsets, pocket sliding doors and risers

2019

Introduced manufacturing of timber doorsets in-house

2023

Extending factory by 40,000sqft to increase capacity and to bring the production of technical door leaves in-house.

Separate division formed for the manufacture and supply of doorsets for the education, healthcare and commercial sectors

COMMERCIAL

Offices, retail shopping centres, public transport, train stations, police stations

PERFORMANCE

Fire Rating - Ranging from FD30 up to FD120 in align with IFC Certification

PAS24:2016 Security Rated

Acoustic Rating up to 48dB Rw

Severe duty

Tested to BS EN 1192/DD171 classified as grade 4 severe duty & tested to BS EN 1191

DESIGN

Full height doors up to 3m

Over panels

EDUCATION

Primary and secondary schools, colleges, universities and student accommodations

PERFORMANCE

Fire Rating - Ranging from FD30 up to FD120 in align with IFC Certification

PAS24:2016 Security Rated

Acoustic Rating up to 40dB Rw

Severe duty

Tested to BS EN 1192/DD171 classified as grade 4 severe duty & tested to BS EN 1191

FEATURES

Safety and compliance guidance of Department for Education (DfE)

Finger protection mechanisms

HEALTHCARE

Hospitals, GP health centres, opticians and dentist practices, mental health units

PERFORMANCE

Fire Rating - Ranging from FD30 up to FD120 in align with IFC Certification

PAS24:2016 Security Rated

Acoustic Rating up to 48dB Rw

Severe duty

Tested to BS EN 1192/DD171 classified as grade 4 severe duty & tested to BS EN 1191

FEATURES

X Ray Doorsets

Anti Bacterial

Postformed doorsets





HIGH-PERFORMANCE
DOORSETS

CLASSROOMS, OFFICES, CONSULTING ROOMS

High-quality, durable doorsets available with vision panels and side screens to promote the transition of natural light into internal spaces.

PERFORMANCE

Fire Rating - Ranging from FD30 up to FD120
Fire rated and manufactured in accordance with the International Fire Consultants Third Party Certification scheme (IFCC)

Acoustic Rating -
Rating up to 40dB Rw

Severe Duty -
Tested to BS EN 1192/DD171 classified as grade 4 severe duty & tested to EN 1191 BM Trada certified

VISION PANELS

Standard vision panel style details, DDA compliant to BS 8300:2009

- Single narrow vision panel
- Single wide vision panel
- Narrow split vision panels
- Wide split vision panels
- Fully glazed
- Privacy blinds

CONFIGURATIONS

Single
Leaf & Half
Side Screen

FINISHES

Veneered
Laminated
PVC
Painted

ACCESS CONTROL

Standalone access controlled (Salto recommended)



CIRCULATION & PUBLIC SPACES

High performance, durable doorsets designed for high traffic circulation and communal areas

PERFORMANCE

Fire Rating - NFR or FD30/FD60S Fire rated and manufactured in accordance with the International Fire Consultants Third Party Certification scheme (IFCC)

The pre-hung factory doorset can meet the requirements for clear opening widths within approved Document M

Severe Duty -

Tested to BS EN 1192/DD171 classified as grade 4 severe duty & tested to EN 1191 BM Trada certified

DESIGN

- Standard
- Full height
- Vision panels
- Double action

CONFIGURATIONS

Single
Double doors
Leaf & Half
Side Screen

FINISHES

Veneered
Laminated
PVC
Painted

ACCESS CONTROL

Network access controlled (Salto recommended)



STORE ROOM & CUPBOARDS

Resilient doorsets designed for high-traffic circulation and public spaces with attention to finish for durability, suitable design options for convenience.

PERFORMANCE

Fire Rating - NFR or FD30/FD60S Fire rated and manufactured in accordance with the International Fire Consultants Third Party Certification scheme (IFCC)

SPECIFICATION

Manufactured with a solid core

- Door leaf constructed from a severe duty core tested to DD171, with hardwood lippings on all 4 sides
- Standard sizes or bespoke available

DOOR FINISHES

Veneered
Laminated
PVC

ACCESS CONTROL

Standalone access controlled (Salto recommended)

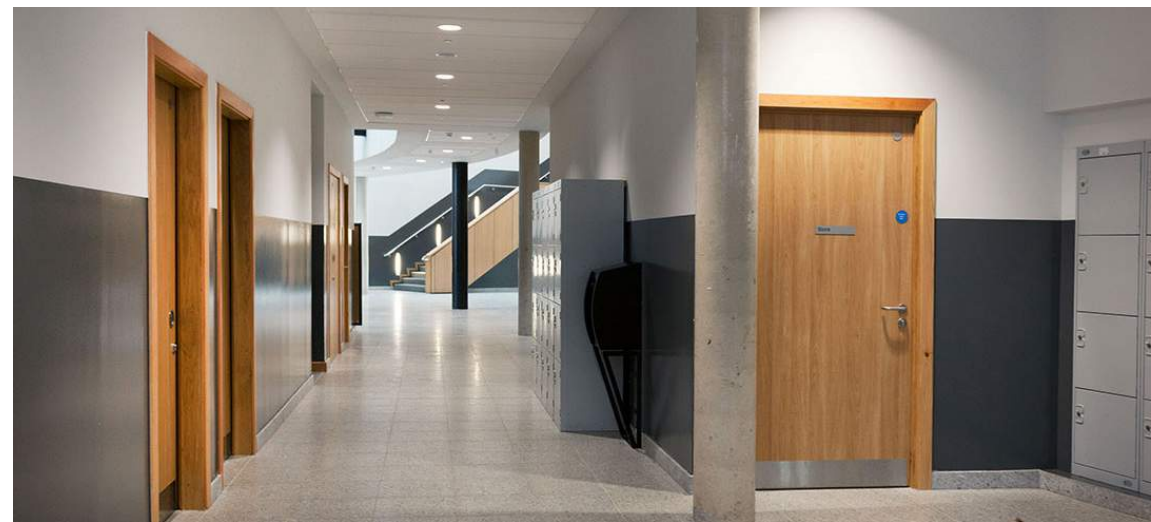

NOVISTA STEEL RISERS

FRAME

Concealed/Picture frame design made from 1.2mm steel. 3 or 4 sided frame options

LEAF

Double skin 1.0mm Zintec Steel with glass wool insulated core. 48mm thick

CONFIGURATIONS

Single leaf, double leaf and up to six leaves within one frame

PERFORMANCE

Fire Rating - FD120(S)

Acoustic Rating - 41dB Rw (as standard)

Smoke/Air tested - To BS6375-1, BSEN1634-3 and to BSEN13501-2

Thermal Resistance - 1.43(m2K)/W

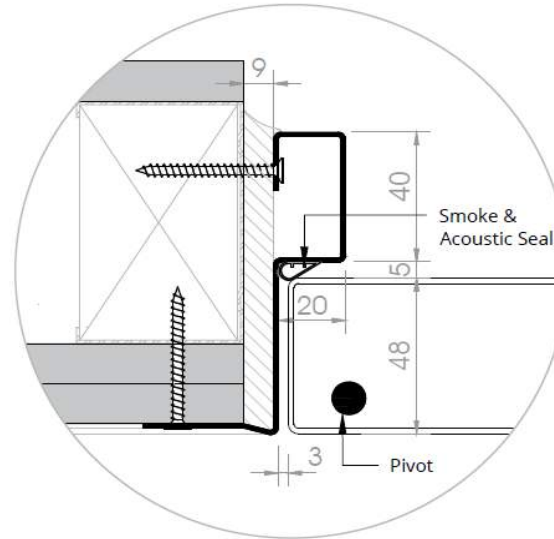

POPULAR CONFIGURATIONS

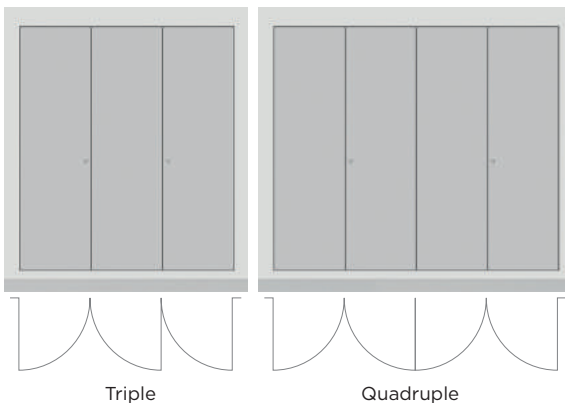

*More options available



NOVISTA TIMBER RISERS

FRAME

Concealed/Picture frame design made from 1.2mm steel. 3 or 4 sided frame options

LEAF

Solid core to suit application*

FD30, up to 2500mm high and 800mm wide
leaves*FD60, up to 2420mm high and 850mm wide*

CONFIGURATIONS

Single leaf & double leaf

PERFORMANCE

Fire Rating - FD30/60

Acoustic Rating - up to 35dB Rw

Smoke/Air tested - To BS6375-1, BSEN1634-3
and to BSEN13501-2

Thermal Resistance - Consult technical dept.

POPULAR CONFIGURATIONS

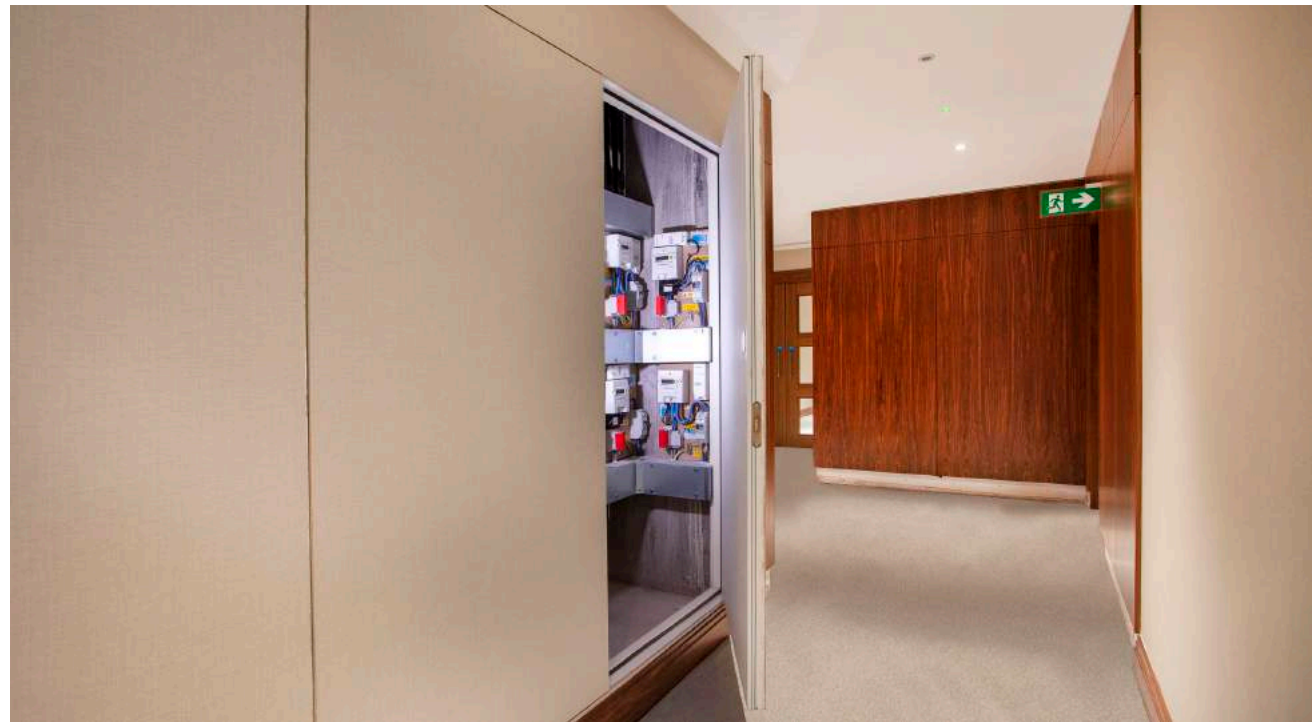
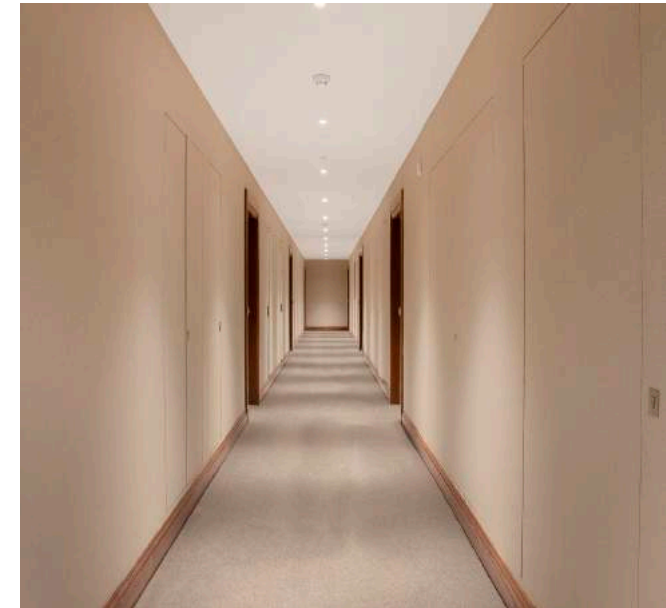
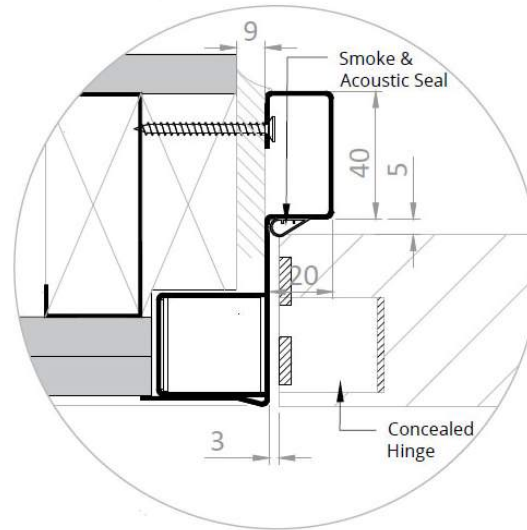
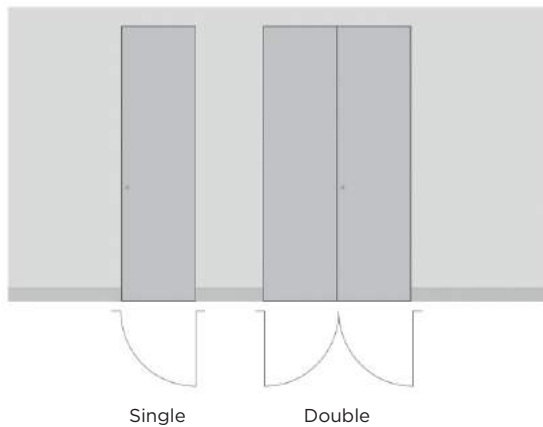

ACOUSTIC DOORS

This sound-proof door is supplied as a complete doorset. Ideal choice for areas requiring above average levels of sound insulation.

SPECIFICATION

- High Density GDC or solid timber laminated core
- Manufactured with a solid core, hardwood lipping on 4 sides. The door leaf is available either Laminated, Veneered, Factory Painted or Primed.
- 8mm hardwood lippings to all 4 sides. Lipping edge can match or contrast the face finish
- Overall thickness: 44mm (32dB), 54mm (35dB), 59mm (43dB), 84mm (48dB)
- Bespoke sizes - 930mm max (w), 2330mm max (h)

PERFORMANCE

- Fire Rating - NFR or up to FD120
- Acoustic Rating - 30dB to 48dB
- Tested to BS EN 1192 / DD171 and classified as grade 4 severe duty
- Manufactured to ISO 9001 standards

DOOR FINISHES

Veneered
Laminated
PVC

CONFIGURATIONS

Single, double, leaf & half and other choices
Vision panel options

ACCESS CONTROL

Standalone access controlled (Salto recommended)



ACCESS CONTROL COMMUNAL

SMART SECURITY

SPECIFICATION

- Access control compatibility with various systems
- Overall thickness 54mm for NFR, FD30 and FD60
- Up to 35dB acoustic rated (with the correct seal arrangement)
- Tested to DD171 and classed as severe duty
- Choice of vision panel design options available

PERFORMANCE

- PAS24:2016 Security Rated (optional)
- Fire tested to BS 476 part 22
- All fire rated doorsets manufactured in align with IFC Certification scheme
- Doorsets meet requirements of Approved Doc M for clear opening widths

CONFIGURATION

- Single



PUSH SIDE

PULL SIDE

Matte Kashmir Laminate

Matte White Laminate

Classic Wenge Veneer



STEEL DOORS (INTERNAL & EXTERNAL)

Quality, secure and certified steel doorsets representing strength and durability, and security features available. Suitable for internal and external use, fits well with residential and commercial spaces.

INTERNAL

- FD60, FD120, FD240
- Single or double configurations
- Panel options - solid, glazed, louvred
- Custom-made in a choice of finishes
- Suitable for Masonry, Concrete and Flexible Stud wall

EXTERNAL

- General purpose external door
- Single or double configurations
- Variety of colours and finishes available
- Custom sizes available
- Hardware already fitted saving time & effort on site

SECURITY

- Intruder and blast security doors
- SECUR-DOR2: low to medium protection, suitable for residential
- SECUR-DOR3: medium protection suitable for residential to commercial
- SECUR-DOR4: medium to high protection

ACCESS CONTROL

Network access controlled (Salto recommended)



A photograph of an office interior featuring a dark grey wall with several rectangular glass vision panels framed in light wood. A white nameplate labeled 'Office 17' and a blue circular sign are mounted on the wall. Two white rectangular panels are visible in the foreground, possibly representing different vision panel options. A semi-transparent grey box is overlaid in the center of the image, containing the text 'DESIGN OPTIONS FOR VISION PANELS'.

DESIGN OPTIONS FOR
VISION PANELS

VISION PANELS

MINIMUM ZONES OF VISIBILITY

Many fire doors within education, healthcare and commercial sectors will include at least one vision panel per door leaf. The position of each vision panel must fall within the guidelines highlighted below to ensure of inclusivity where all types of users can benefit from the vision panel.

To ensure your fire doors are compliant with Building Regulations Part M: Mobility, we have provided a few diagrams to support correct design and specification criteria.

Please use these in conjunction with the latest building regulation codes to comply with compliance and relevant standards.

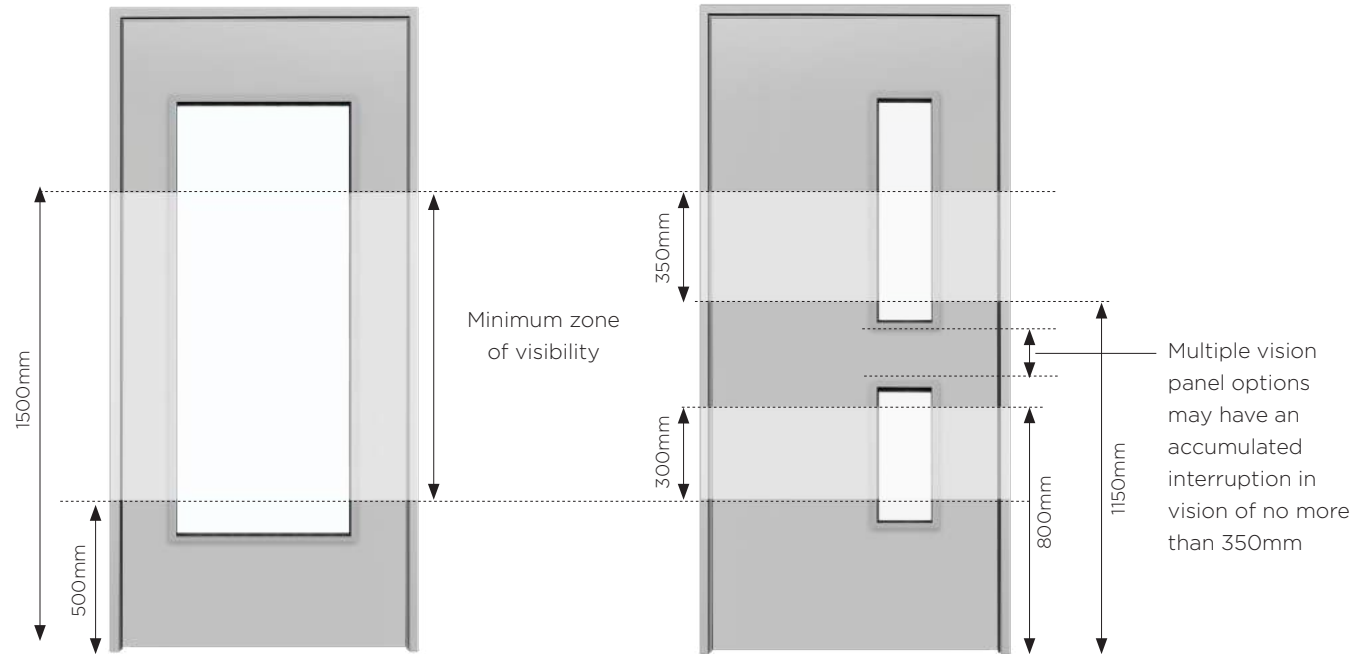

VISION PANEL OPTIONS

The vision panels shown are our most commonly used designs.

Alternative design options are available, subject to fire certification and minimum aperture margins.

Glazed bead dimensions and seal arrangements will vary depending on fire and acoustic certification.

 In compliant with BS 8300 for wheelchair accessibility

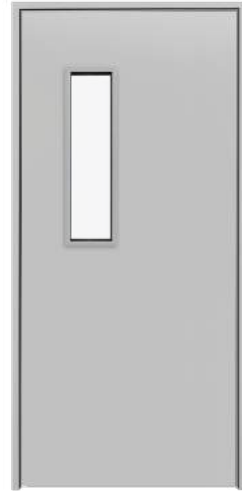

VP-A

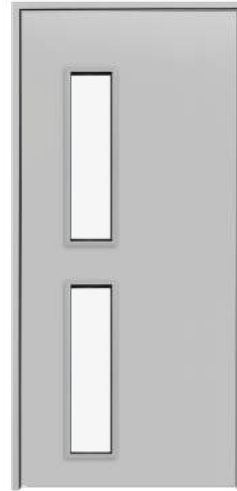

VP-B

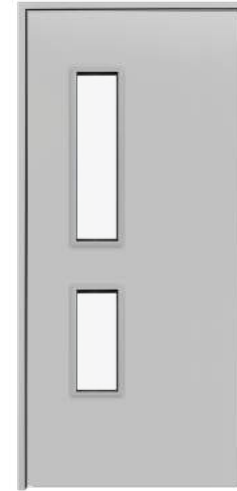

VP-C

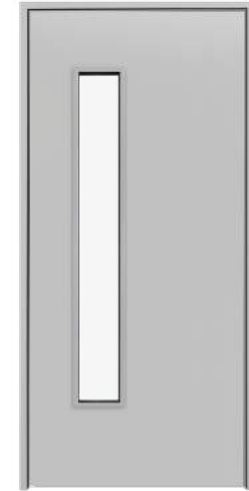

VP-D

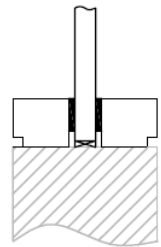

Flush - Hardwood

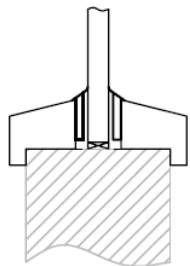

Bolection - Hardwood

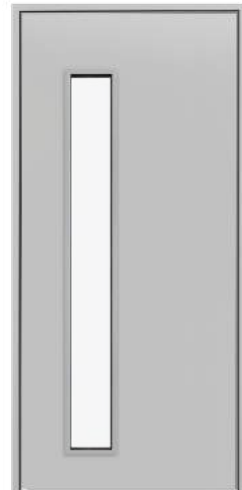

VP-E

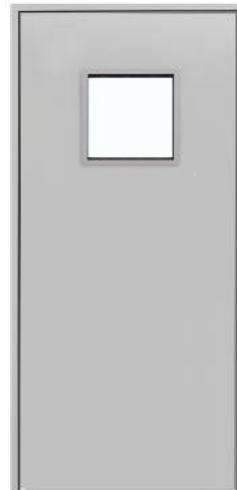

VP-F

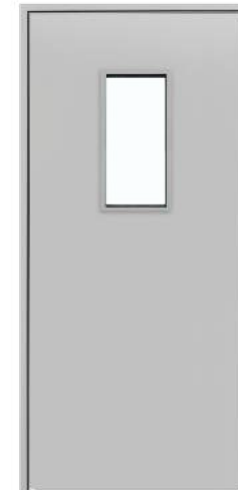

VP-G

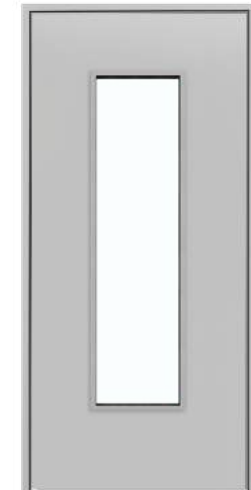

VP-H





CONFIGURATIONS
& FRAME TYPES

CONFIGURATIONS

STANDARD CHOICES, BESPOKE AVAILABLE

SINGLE DOOR CONFIGURATIONS

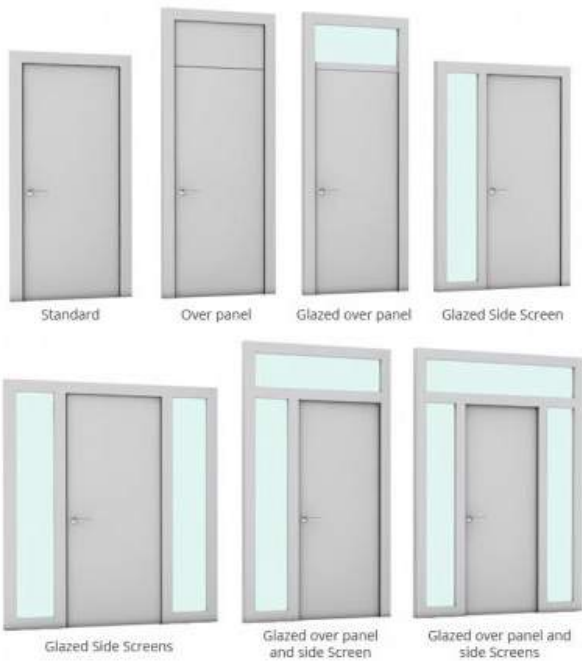

LEAF & HALF CONFIGURATIONS

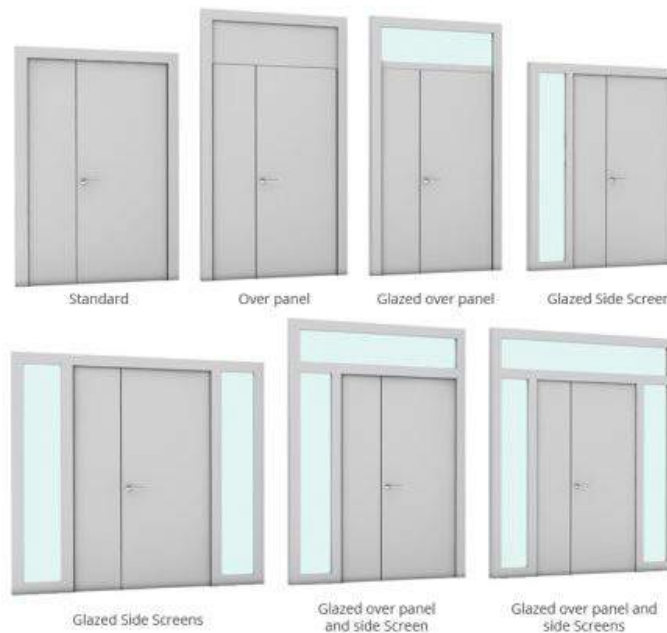

DOUBLE DOOR CONFIGURATIONS

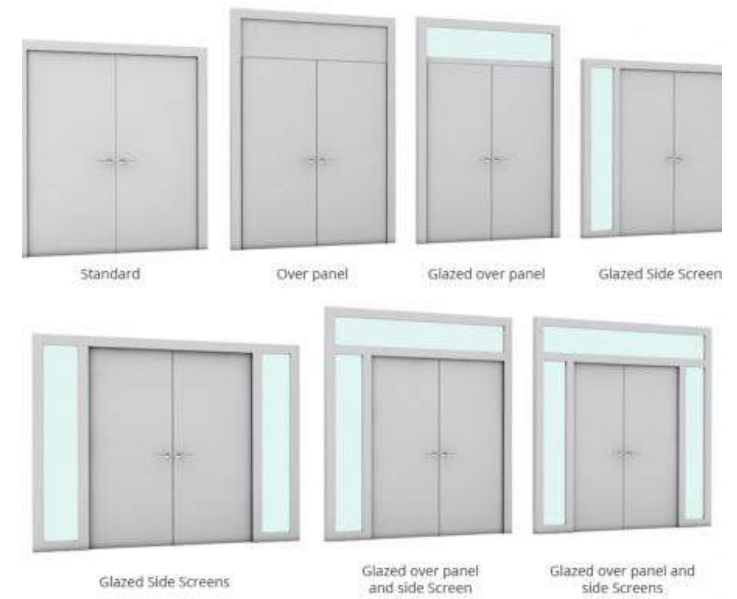

Multiple screen option available, please contact us for more details - info@aspex.co.uk.

FRAME TYPES

WITH UNIQUE FEATURES

A wide selection of different door frames can be supplied, manufactured from either MDF, softwood, hardwood, or steel, and each of these materials has its own unique advantages.

Standard lining, and stop or rebated frames, are available, together with specialist types for sports halls or finger protection choices.

FRAME TYPE ONE -
LINING AND STOP



FRAME TYPE TWO -
REBATED



FRAME TYPE THREE -
SPLIT WITH SEPARATE
ARCHITRAVES



FRAME TYPE FOUR -
REBATED WITH INTEGRATED
ARCHITRAVES



FRAME TYPE FIVE -
DOUBLE SWING





DESIGNED WITH CARE FOR
HEALTHCARE

POSTFORMED PVC DOORSETS

Postformed PVC doorsets are fully encapsulated with protective, specialist sheets enhancing the durability, better hygiene and ease of cleaning, and scratch-resistant. These doorsets are also anti-bacterial and suitable for 'wet room' areas.

FEATURES

- Specialistic protection for door frames
- Plastic layered protection maintains a clean safe environment
- Reduces maintenance costs by protecting the frame from damage
- Enhances durability of doorsets in bathrooms or leisure centre, protecting against the risk of swelling
- Optimises the safety of staff and patients in the event of a fire by maintaining fire integrity of the door allowing safe evacuation

PERFORMANCE

- Fire Rating - NFR, FD30, FD60 in align with IFCC Certification scheme Class and 'O' Fire Rated; tested to BS 476 Parts 6 & 7
- Compatible with fire and acoustic performance

DESIGN

- Available in any colour
- Vision panel option
- X-ray and electromagnetic protection option (NFR only)
- Purpose-made to sizes





PIONEERING GLAZED PRIVACY VISION PANELS

For several years, we have been working with Vistamatic to offer Vistamatic world-leading glazed privacy vision panels; the ideal selection for hospitals and mental care facilities.

Vistamic panels are designed for healthcare environments to protect privacy and support essential observation and monitoring.

There are a wide range of products to support the diverse requirements of patient support.



VISTAMATIC

ANTI-LIGATURE



High integrity glazing placed inside a stainless steel frame and is operated by a lockable key or an anti-ligature thumb turn

GLAZING OPTIONS

- Toughened Glass
- Laminated
- Fire Rated - FD30 and FD60 Acoustic
- Standard: 404mm X 404mm and 800mm X 250mm
- Bespoke: Width - 150mm to 1000mm; Height - 200mm to 1500mm

SIZE OPTIONS

- Standard Sizes are:
404mm X 404mm and 800mm X 250mm
- Bespoke size available:
Width from 150mm to 1000mm;
Height from 200mm to 1500mm

BLACKOUT



Viewing aspect remains the same while the panel is open but when closed, 97-98% light is filtered out

GLAZING OPTIONS

- Toughened Glass
- Laminated
- Fire Rated - FD30 and FD60
- Acoustic
- Lead
- Laser*

SIZE OPTIONS

- Standard Sizes are: 404mm X 404mm and 800mm X 250mm
- Bespoke size available*:
Width from 150mm to 1000mm;
Height from 200mm to 1500mm

SLIDE



Vista Slide is perfect for doors where greater observation is needed as well as walls/partitions to monitor corridor

GLAZING OPTIONS

- Toughened Glass
- Laminated
- Fire Rated - FD30 and FD60
- Acoustic
- Lead
- Laser

SIZE OPTIONS

- Bespoke size available:
Width up to 1500mm;
Height up to 1200mm

HANDLE OPTIONS

- Standard lever
- Large lever
- Key locking
- Thumb turn

VISTAMATIC

MAX



Secure, triple glazed system allows secure observation whilst maintaining the appearance of a contemporary Venetian style blind

GLAZING OPTIONS

- Toughened Glass
- Laminated
- Fire Rated - FD30 and FD60
- Acoustic
- Lead
- Laser*

SIZE OPTIONS

- Standard Sizes are: 404mm X 404mm and 800mm X 250mm
- Bespoke size available*:
Width from 150mm to 1000mm;
Height from 200mm to 1500mm

MAX XL



Vista Slide is perfect for doors where greater observation is needed as well as walls/partitions to monitor corridor

GLAZING OPTIONS

- Toughened Glass
- Laminated
- Fire Rated - FD30
- Acoustic
- Lead
- Laser* (Restrictions may apply)

SIZE OPTIONS

- Bespoke size available:
Width from 175mm to 500mm;
Height from 1100mm to 1500mm

LEAD & LASER PROTECTION



Hand-crafted vision panels with either lead glass or with a laser polymer/vinyl shield suitable for rooms involving x-rays, lasers or radiation

GLAZING OPTIONS

- Toughened Glass
- Laminated
- Fire Rated - FD30 and FD60
- Acoustic
- Lead
- Laser*

SIZE OPTIONS

- Standard Sizes are: 404mm X 404mm and 800mm X 250mm
- Bespoke size available*:
Width from 150mm to 1000mm;
Height from 200mm to 1500mm



DESIGN FEATURES
& FINISHES

DESIGN FEATURES

BI-FOLDING

Bi-folding doors can be sliding or folding to enhance functionality and access, ideal solutions when space is limited. This innovative two-leaf interconnected door solution reduces door swing area while maximising clear opening widths, in align with Approved Document M and BS 8300:2001.

Bi-folding doors are recommended for outward opening WC doors, door openings onto landings, lobbies with space required for wheelchair access, sanitary accommodation doors opening outward onto circulation spaces etc.

These smart bi-folding door solutions can be NFR or FD30 in align with IFC certification and BS476 Part 22 1987, and they are fire and smoke resistance.

DOUBLE-ACTION

Double-action doors, also known as double-swinging doors, are practical door solutions that can swing in both directions enhancing convenience.

These solutions are most commonly used in hospitals, healthcare clinics, where the door must open in both directions in the case of emergencies allowing staff and patients fast, smooth movement.

For example, if someone is in distress and locked in a room then the door cannot open inwards because it is blocked, these doors can be opened outward too allowing assistance and care to be provided to the person. Also, an ideal solution for disabled toilet doors that need to be able to open inwards and outwards.

FINGER PROTECTION

Safehinge is a smart, protective finger safe protection solution preventing crushing and shearing of fingers (suited for both adults and children).

The system's sleek design integrates perfectly with the door and frame making it the most unobtrusive finger protection system available. The aluminium profile that fits onto the edge of the door has an integral pivot and top centre for single or double action doors. If the doors are required to self-close, a standard overhead door closer can be used on single swing doors and a floor spring or transom closer on double swing doors.

This solution is suitable for single or double action doors, fire tested with FD30 or FD60 doors with acoustic rating up to 38dB (glazed doors) They are fully compliant with Approved Documents and can be incorporated into all design applications, in align with severe duty DD171.



PVC

FINISH OPTION

Choose impact-resistant, highly hygienic PVC surfaces ideal for clean rooms, washrooms and laboratories.

Other colours may be available to suit RAL codes, please contact us for more information.

GREYS/BLACK

SNOW WHITE TEXTURED
NEAREST RAL 9001
LRV 73.85

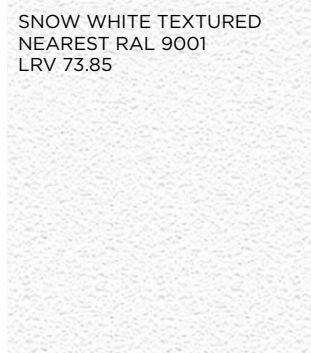

PALE GREY TEXTURED
NEAREST RAL 7044
LRV 51.38



STORM GREY TEXTURED
NEAREST RAL 7037
LRV 21.66



BLACK SMOOTH
NEAREST RAL 9011

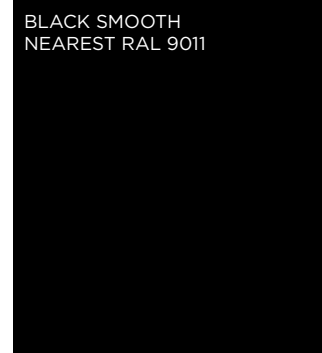

LIGHT SHADES

IVORY TEXTURED,
NEAREST RAL 1013.
LRV 73.85

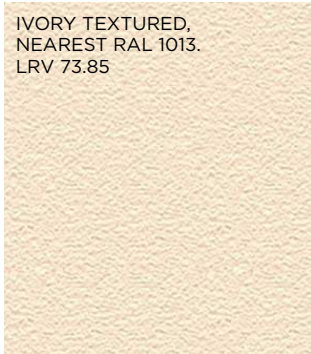

PASTEL GREEN
SMOOTH
LRV 70

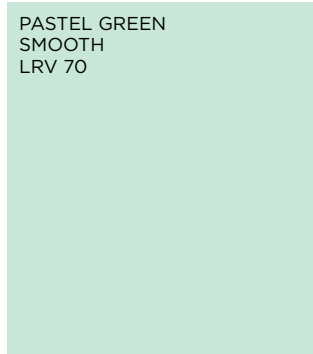

PASTEL BLUE
SMOOTH LRV 52

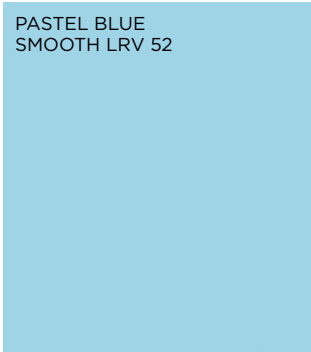

AVOCADO SMOOTH
LRV 34

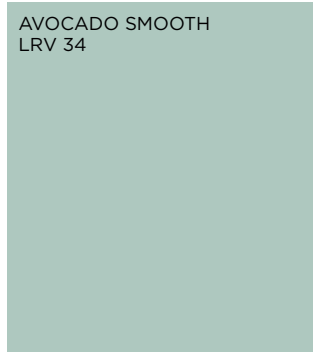

BRIGHT SHADES

RED SMOOTH
LRV 3

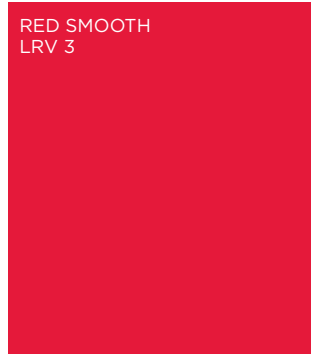

PINK SMOOTH
LRV 13

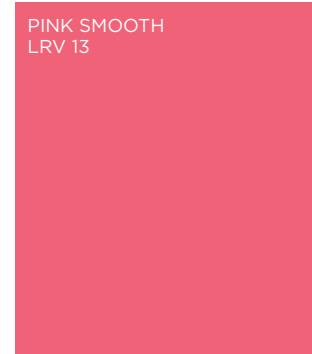

PURPLE SMOOTH
LRV 9

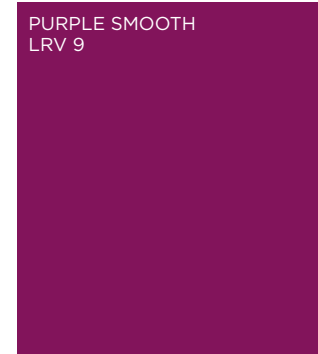

ORANGE SMOOTH
LRV 26

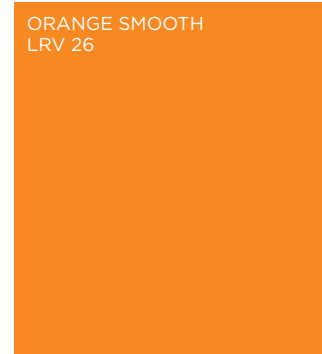

TWILIGHT BLUE TEXTURED
NEAREST RAL 5003
LRV 8.25



PALE BLUE TEXTURED
NEAREST RAL 5024
LRV 31.03

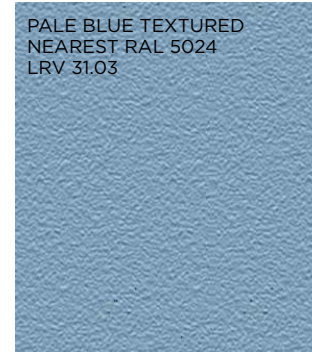

PALE GREEN TEXTURED
NEAREST RAL 6034
LRV 37.32



POSEIDON BLUE TEXTURED
NEAREST RAL 5012
LRV 27.13

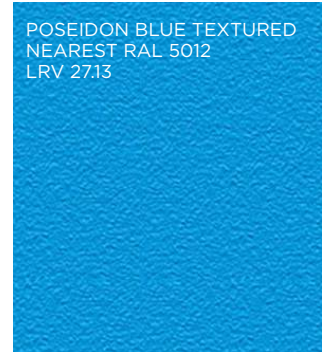

LAMINATES

FINISH OPTION

Choose beautiful laminate finishes to enhance your interiors.

Excellent range of colour or wood alike laminates.

We hold an exclusive direct-supply agreement with Formica, and work with Egger and Polyrey too.

*More options available

COLOUR LAMINATES

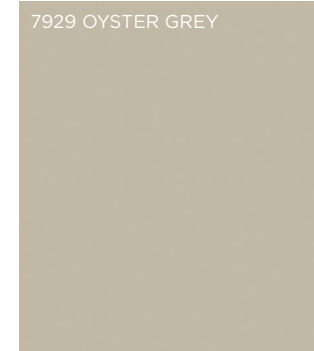
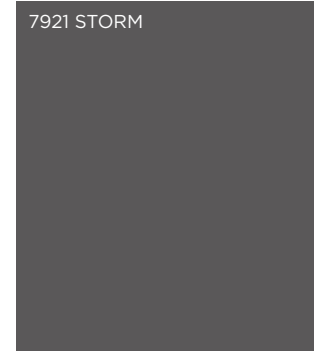
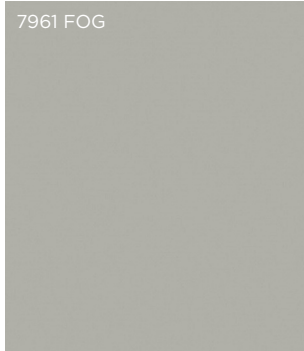

WOOD LAMINATES

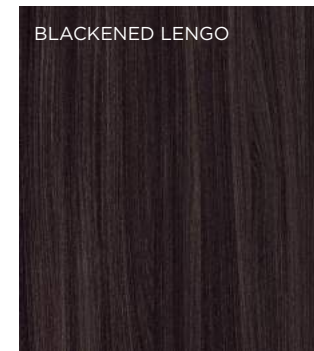
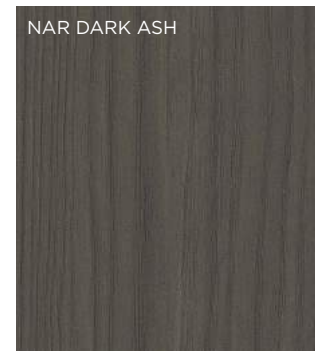
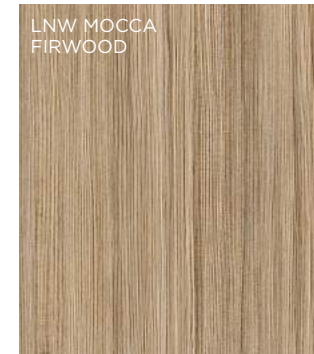

VENEERS

FINISH OPTION

Choose luxurious veneers finishes - from natural, dyed, smoked and reconstituted finishes.

*More options available

NATURAL/EXOTIC VENEERS



RECONSTITUTED/SMOKED VENEERS

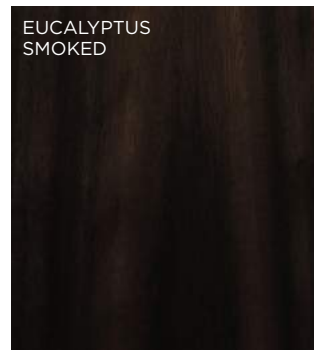
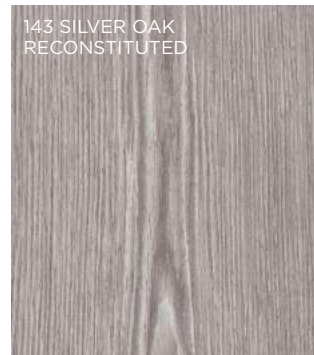
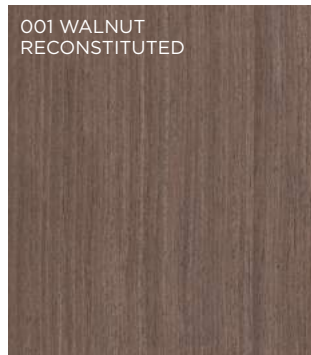

DYED VENEERS

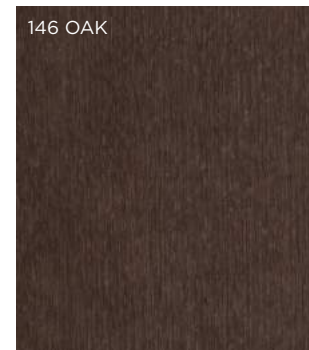
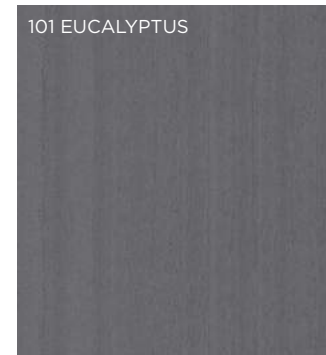
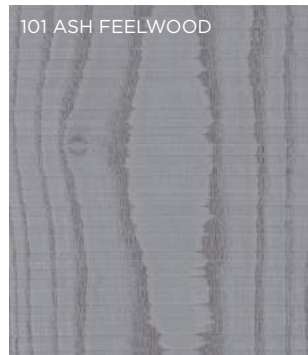

PAINT

FINISH OPTION

Choose any RAL colour to closely match your doorset to complement your interior design.

Bespoke colour options available

*More options available

BLACKS

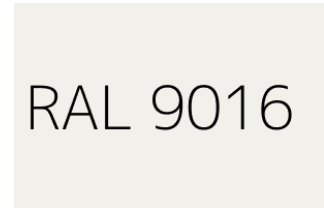
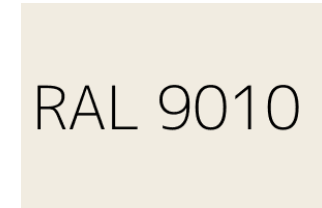
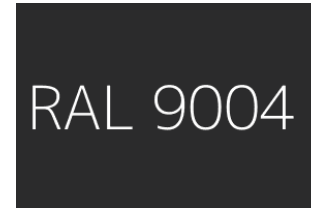
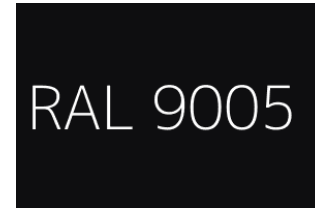

BROWNS

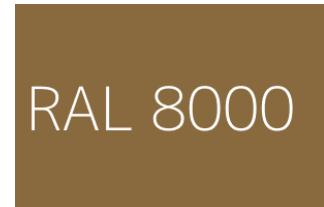
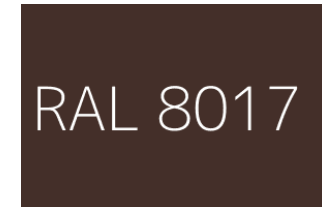
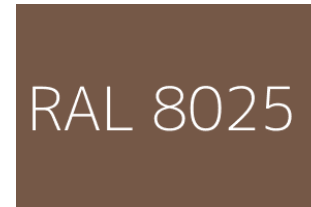
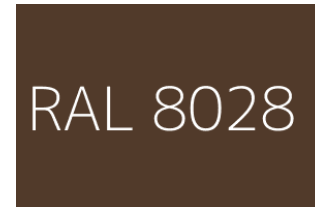

BLUES

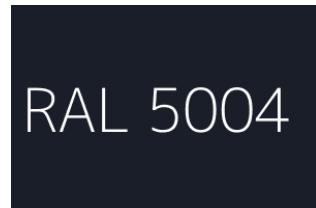

GREYS

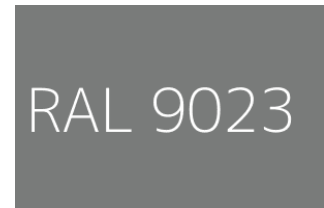
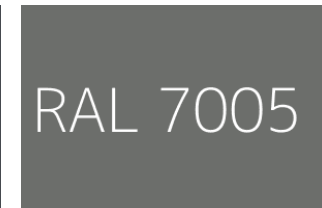
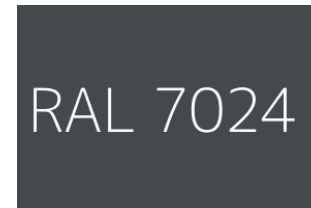
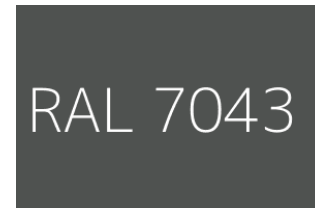

REDS

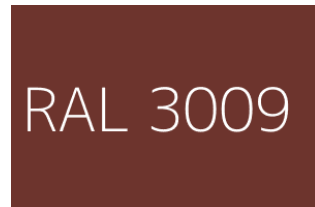
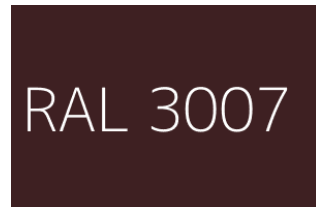

GREENS

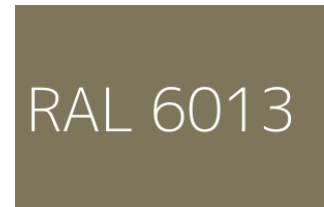
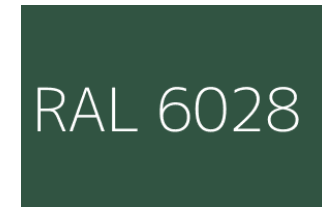
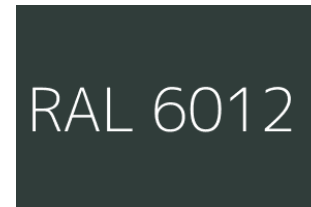
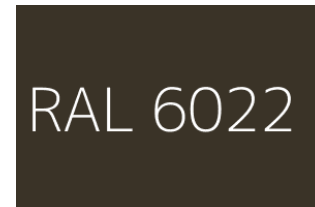

STYLE INSPIRATION

DESIGNS

C1 Single Door, Flush



C2 Single Door, VP-D



C3 Single Door, VP-B Split Vision



C4 Single Door with Screen



C5 Leaf & Half, Flush



C6 Double Doors, Flush

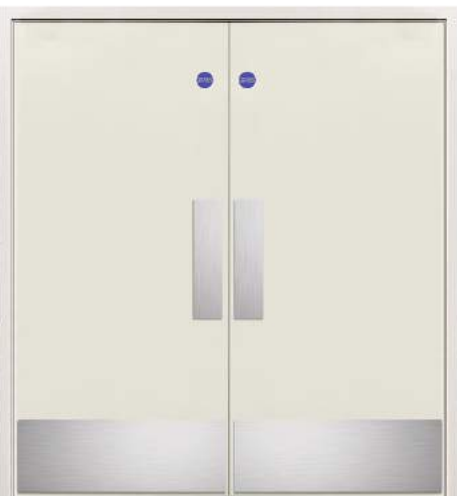

C7 Double Doors, VP-D



C8 Double Doors, VP-B Split Vision



C9 Leaf & Half, VP-D





IRONMONGERY &
ACCESS CONTROL

IRONMONGERY

PURPOSE-LED RANGE

Ultimate solution of architectural ironmongery from...

- ✓ Lever handles
- ✓ Pull handles
- ✓ Escutcheons
- ✓ Turns and releases
- ✓ Hinges
- ✓ Signage
- ✓ Locks & cylinders
- ✓ Door closers
- ✓ Panic Hardware
- ✓ Miscellaneous

Range of finishes...

- ✓ Satin stainless steel
- ✓ Polished stainless steel
- ✓ Aluminium
- ✓ Nylon
- ✓ Black
- ✓ Bronze
- ✓ Brass

In align with relevant standards...

- CE Marked
- BS 8300
- BS EN
- Certifire



HEALTHCARE

High-performance, durable and smart ironmongery available in suitable finishes including stainless steel, aluminium, nylon.

Washroom and WC fittings designed for disabled users include stainless steel, nylon and aluminium powder coating.



EDUCATION

Resilient, quality and innovative ironmongery with finger protection, anti-bacterial and sophisticated features. Most suited stainless steel, aluminium, nylon finishes available. Robust nylon helps add pop of colour and does not chip or flake off. Braille and tactile signage available too.



COMMERCIAL

Quality, functional ironmongery with attractive aesthetics available in a variety of finishes from stainless steel to black, in adherence to relevant standards.

ACCESS CONTROL

SMART, INNOVATIVE SOLUTIONS

Aspex are a proud Platinum Inspired Business Partner of Salto offering seamless, relevant and efficient solutions.

As a dedicated solution provider, we offer the complete package from - supply, installation and maintenance support.

We work a range of leading manufacturers...

SALTO

ASSA ABLOY

Paxton

OMNITEC

alhua
TECHNOLOGY

HIKVISION



ESCUTCHEONS

XS4 One Escutcheons need no hard-wiring, battery-operated. All-in-one smart lock designed to fit on any door type & retrofits.



WALL READERS

Smart wall readers integrate with any type of access control application - doors, barriers, lifts, electronic gates etc.



TURNSTILES

Manage crowd-control, prevent tailgating with smart turnstiles. Integrated with building access control system



AUTOMATED DOORS

Control of automated doors integrated with access control, fire alarm systems and supporting disability access



PANIC EXIT BARS

Highest safety standards with ease of use. EN1125 compliant in combination with Salto XS4 electronic escutcheon



CAR PARK BARRIERS

Seamless integration with existing management systems. ANPR car park barrier, intercom features, keyless access possible



Let's work on specifications together, find us on...



NBS Chorus



NBS Source
PARTNER

FREE SAMPLES

Request for door leaf samples & ironmongery sample board to see how well we can match your project requirements.
Simply email sales@aspex.co.uk

GET IN TOUCH

www.aspex.co.uk | info@aspex.co.uk
England office: 0116 278 3506
Scotland office: 01236 720061

aspex