

aspex

DOORSETS FOR HOTELS
Ultimate interior fitout solutions

DOORSETS | IRONMONGERY | ACCESS CONTROL

www.aspex.co.uk | info@aspex.co.uk



DOORS FOR HOTELS

DESIGNED TO IMPRESS & SECURE

DESIGNS

Panelled



Grooved



Flush



FINISHES

Painted



Veneer



Laminated

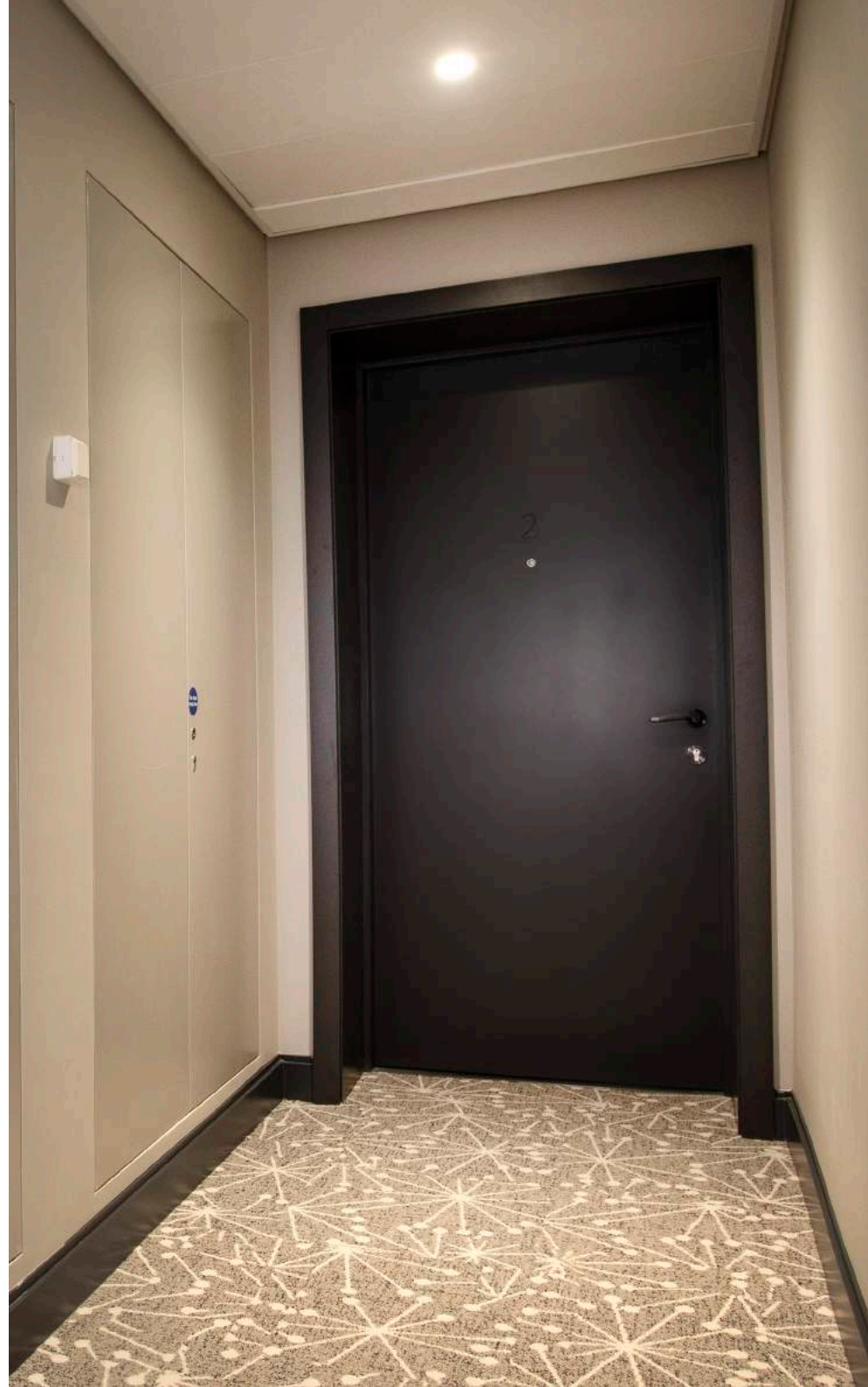

ENTRANCE DOORSETS

DOOR SPECIFICATION

All fire doors are purpose-made to sizes required, extensive size ranges are validated by an independent tests or authoritative assessment

- Door leaf constructed from a severe duty core tested to DD171, with hardwood lipping's on all 4 sides
- Structural opening size of up to 2400mm high and 1310mm wide
- **DOOR FINISHES:** Primed, Painted, Veneered, Laminated. Matching frames available.
- **FRAME OPTIONS:** Extension linings & architraves. Options - Hardwood, Softwood & MDF frames

PERFORMANCE

- Fire tested to BS 476 part 22
- Fire rating - FD30S (44mm) and FD60S (54mm)
- All fire rated doorsets manufactured under the stringent IFC certification scheme
- Doorsets meet requirements of Approved Doc M for clear opening widths
- Acoustic rating - 29dB, 32dB and 35dB options
- Smoke/ Air tested - compression smoke seals tested in accordance with BS - 9999:2017



EN-SUITE DOORSETS

SPECIFICATION

Manufactured with a solid core

- Door leaf constructed from a severe duty core tested to DD171, with hardwood lipping's on all 4 sides
- Standard sizes or bespoke
- **DOOR FINISHES:** Primed, Painted, Veneered, Laminated. Matching frames available.
- **FRAME OPTIONS:**
Hardwood, Softwood, MDF frames

PERFORMANCE

- NFR



ACCESS CONTROL COMMUNAL

SMART SECURITY

SPECIFICATION

- Access control compatibility with various systems
- Overall thickness 54mm for NFR, FD30 and FD60
- Up to 35dB acoustic rated (with the correct seal arrangement)
- Tested to DD171 and classed as severe duty
- Choice of vision panel design options available

PERFORMANCE

- Fire tested to BS 476 part 22
- All fire rated doorsets manufactured under the stringent BWF Certifire scheme
- Doorsets meet requirements of Approved Doc M for clear opening widths



Matte Kashmir Laminate

Matte White Laminate

Classic Wenge Laminate



PANEL DOORS

DESIGN CHOICE

Luxurious panelled design, great look & feel features enhancing your interiors.

- ✓ 2 Panels
- ✓ 3 Panels
- ✓ 4 Panels

FRAME OPTIONS: Primed frame or matching veneered frame. Extension linings & architraves.

FINISHES

- **Primed** - Smooth finish for onsite painting
- **Factory-painted**- Any RAL colour with the option for different colours on each side
- **Veneered** - Natural wood or dyed options to choose from
- **Stained** - Select from a standard range or bespoke to match other elements in the apartment

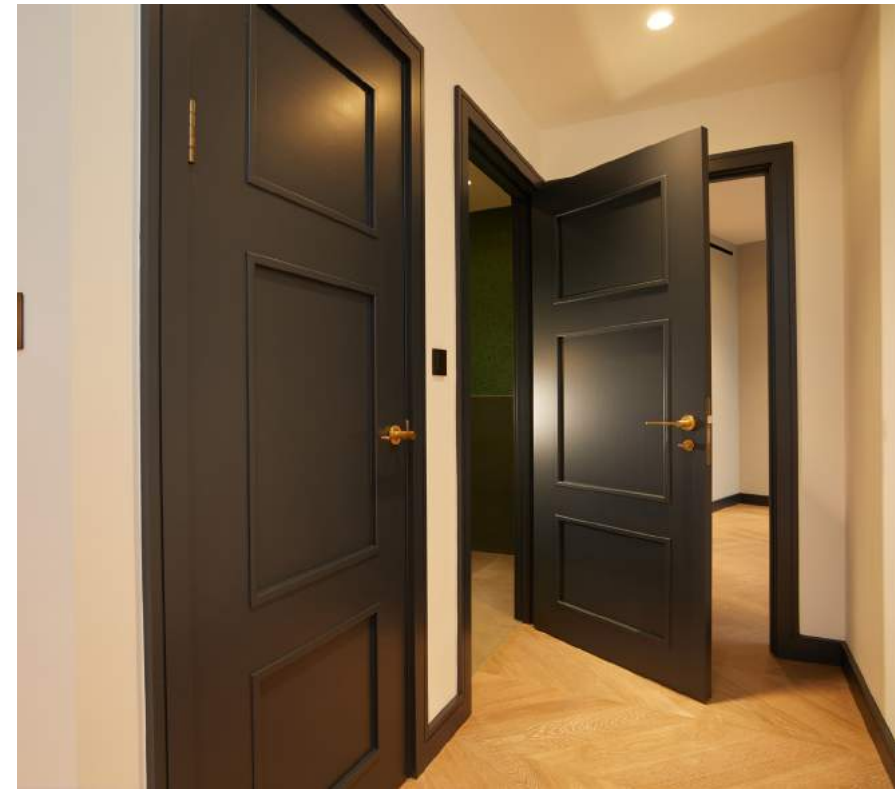
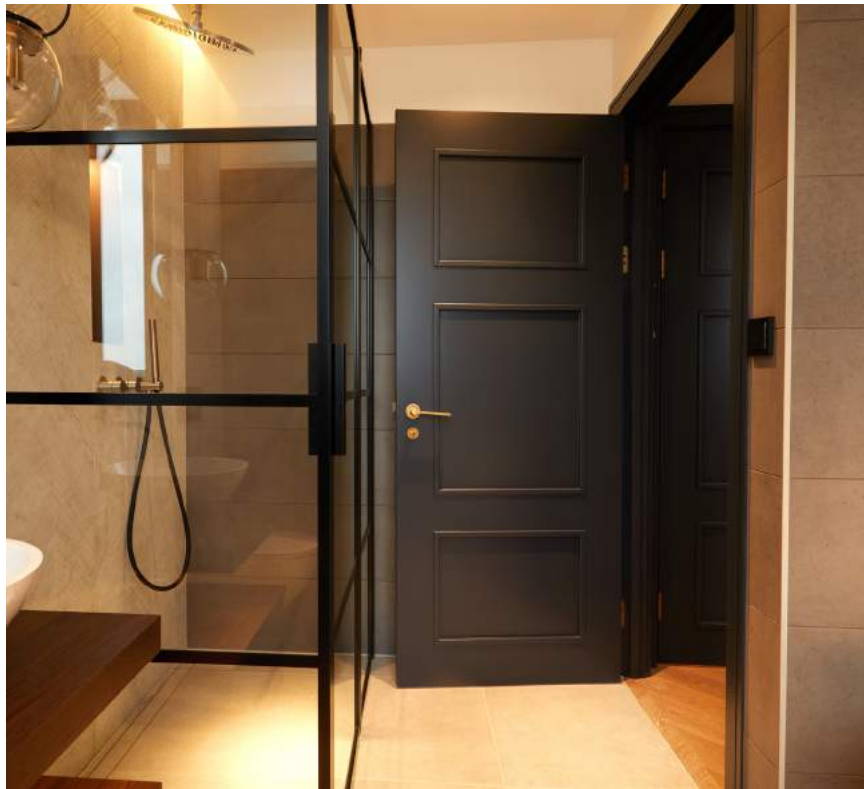

GROOVED DOORS

DESIGN CHOICE

Simply stunning grooved design, attention to detail features enhancing your interiors.

- ✓ Ladder
- ✓ Rectangular
- ✓ Bespoke

Groove options:

- ✓ V shape
- ✓ U shape
- ✓ □ shape

Inlay options:

- ✓ Contrasting Veneer
- ✓ Aluminium
-

FINISHES

- **Primed** - Smooth finish for onsite painting
- **Factory-painted**- Any RAL colour with the option for different colours on each side
- **Veneered** - Natural wood or dyed options to choose from
- **Stained** - Select from a standard range or bespoke to match other elements in the apartment

Ladder design



Rectangular design



Veneered + Grooved

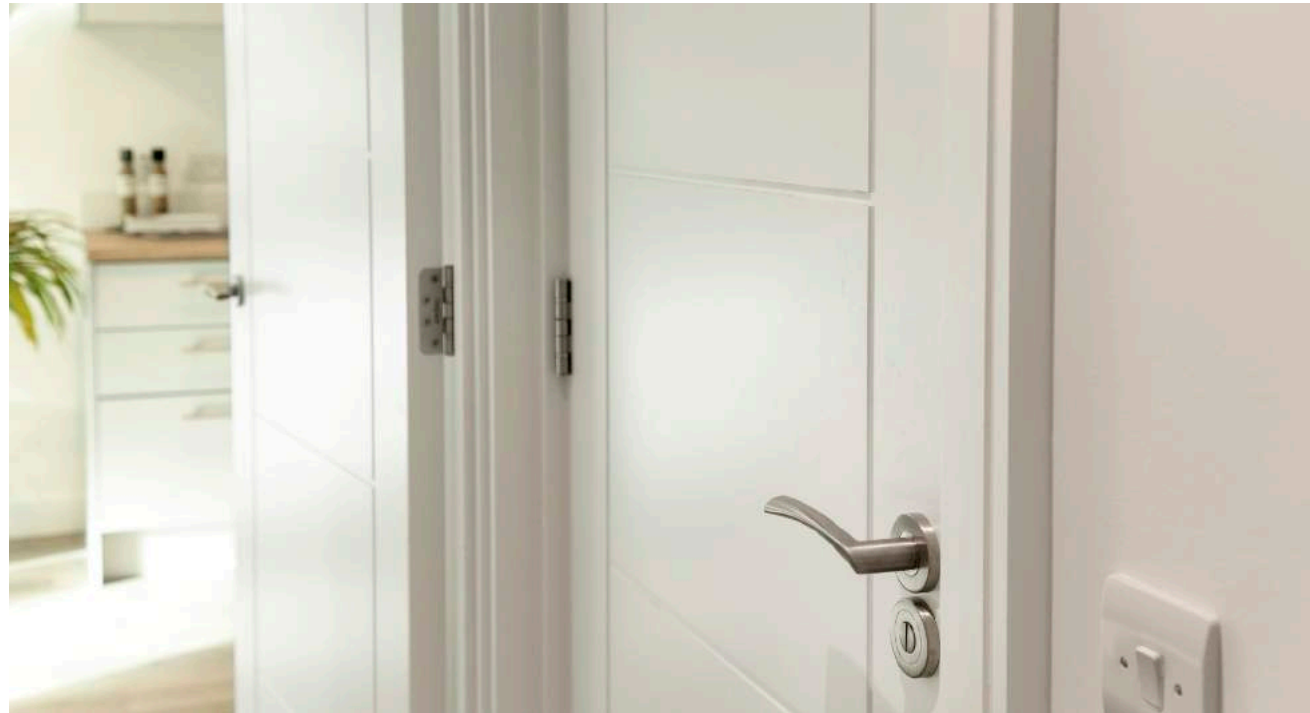

FLUSH DOORS

DESIGN CHOICE

Contemporary, elegant flush entrance and en-suite doors

All timber doors are FSC certified.

- ✓ Factory painted
- ✓ Laminated
- ✓ Veneered
- ✓ Veneered with in-lays



VENEER DOORS

FINISH CHOICE

Real wood veneers allow the beauty of the natural wood grain and tone to be brought to life, creating a finish that preserves its true presence.

- ✓ Matt Lacquer
- ✓ Super-matt Lacquer
- ✓ Natural Veneer Crown or Quarter Cut
- ✓ Engineered Veneers
- ✓ Dyed Veneers
- ✓ Stained Veneers

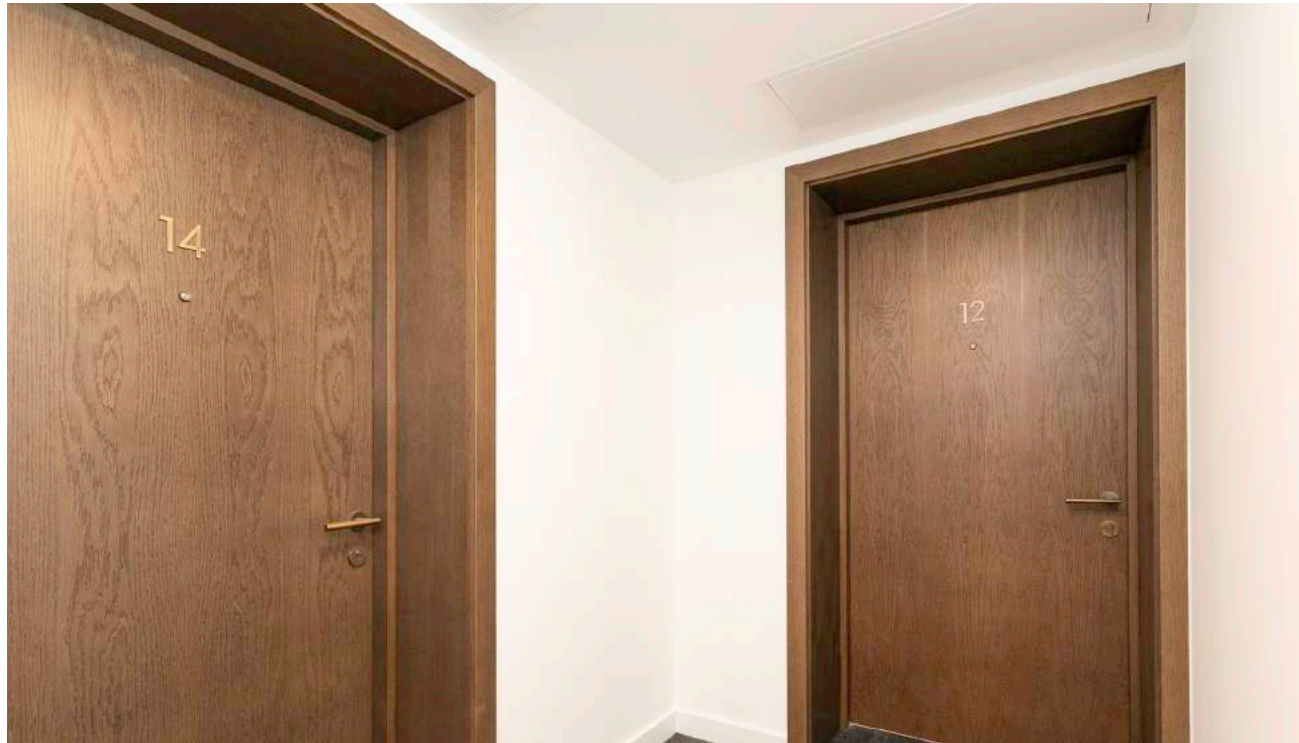
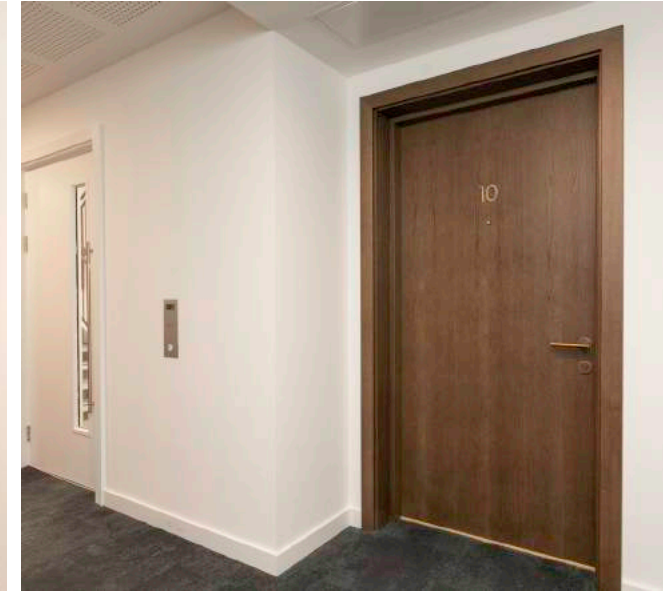

LAMINATES

FINISH CHOICE

Hard-wearing laminates are ideal for both aesthetic and durability requirements.

- ✓ Laminates are durable and hygienic
- ✓ Ideal choice for high-traffic door applications
- ✓ High-performance surfacing solution

Available in a range of colour and wood texture choices



PAINTED FINISH CHOICE

Popular factory-painted doors allow you to touch-up as needed, enhancing the look & feel easily.

Choose any RAL colour to closely match your interior look. Excellent range of standard and bespoke RAL colours

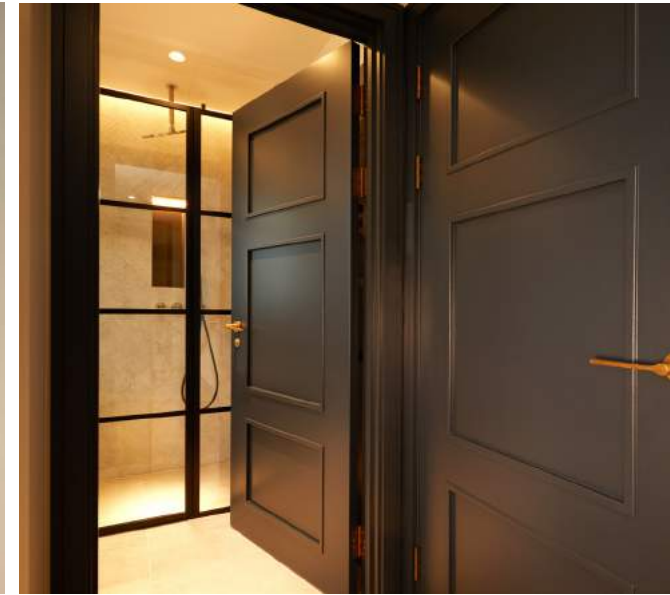

VENEERS

Choose luxurious veneers finishes - from natural, dyed, smoked and reconstituted finishes.

*Not exhaustive list

NATURAL/EXOTIC VENEERS

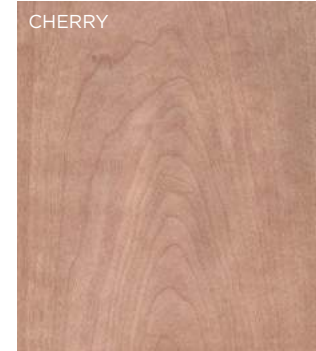

RECONSTITUTED/SMOKED VENEERS

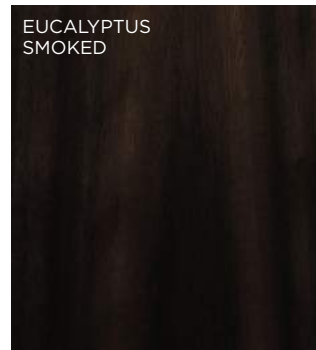

DYED VENEERS

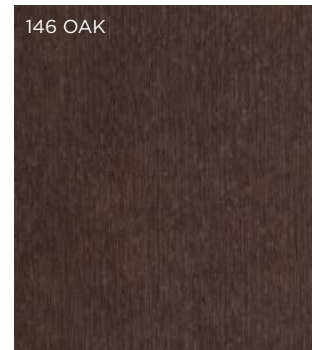
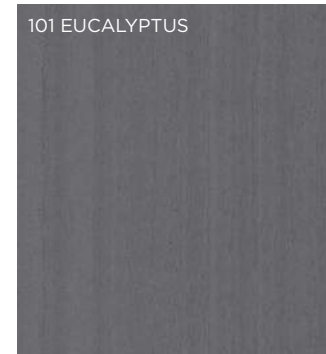
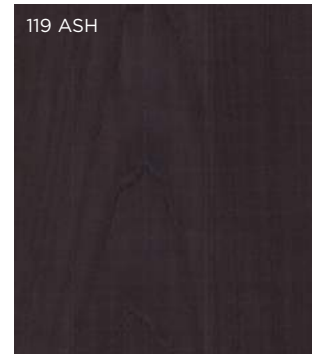
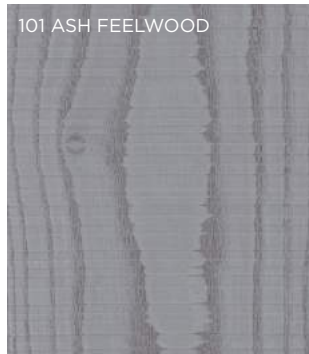

LAMINATES

Choose beautiful laminate finishes to enhance your interiors.

Excellent range of colour or wood alike laminates.

*Not exhaustive list

COLOUR LAMINATES

7961 FOG



7921 STORM

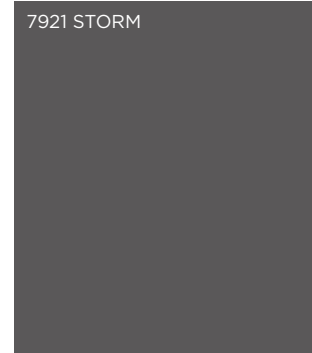

7929 OYSTER GREY

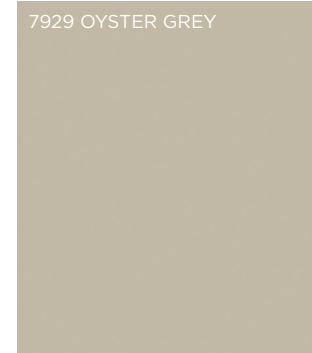

5349 FOSSIL

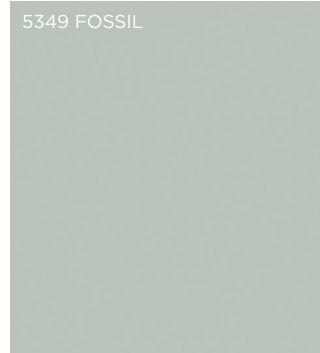

WOOD LAMINATES

WHITE ASK



AGED ASH



NAT ELEGANT OAK



NAT LIGHT OAK



LNW MOCCA FIRWOOD

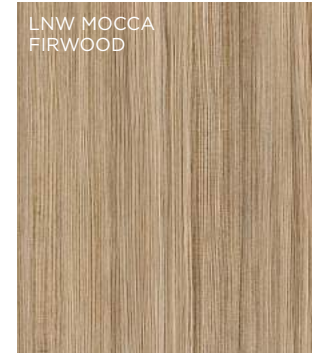

JARRAH LENGO



TOLA OAK

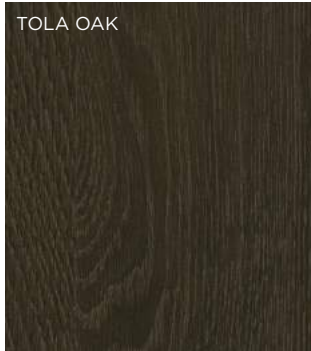

NEVADA OAK



NAR DARK ASH

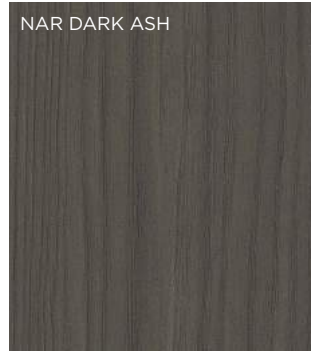

NAT BLACK BIRCH-PLY

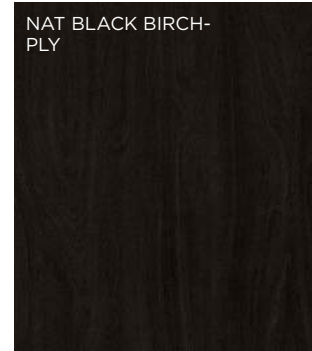

BLACKENED LENGO

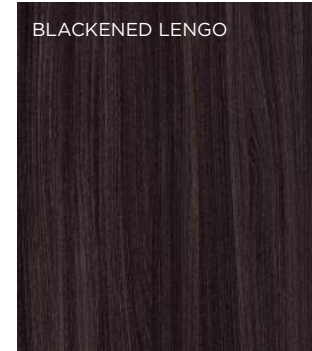

LNW CLASSIC WENGE



PAINT

Choose any RAL colour to closely match your doorset to complement your interior design.

Bespoke colour options available

*Not exhaustive list

BLUES

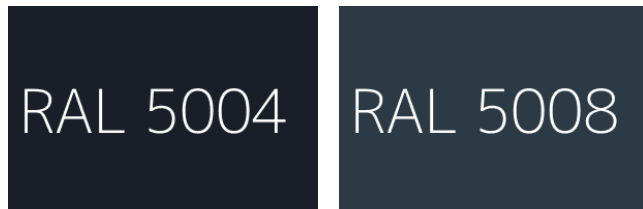

REDS



BLACKS

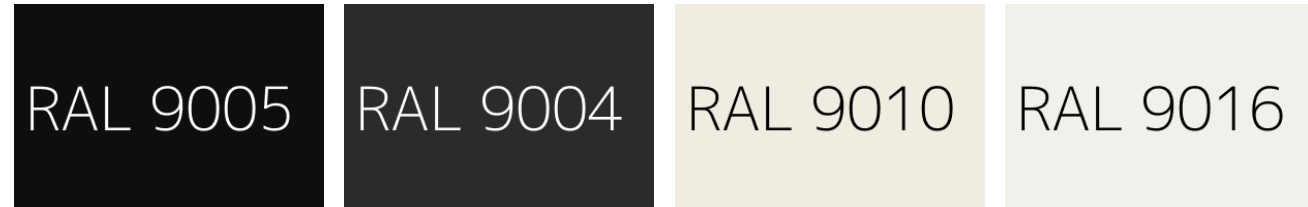

BROWNS

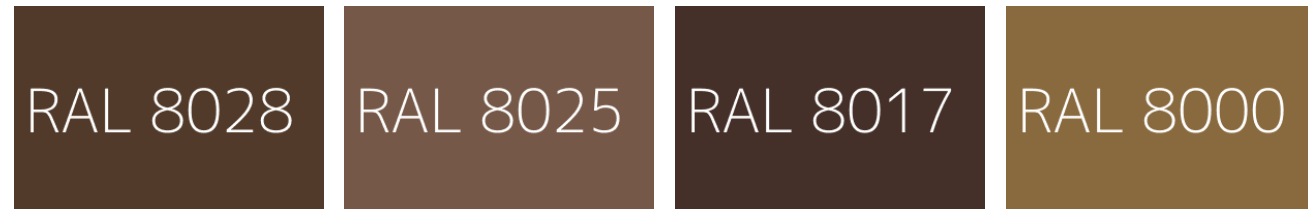

GREYS

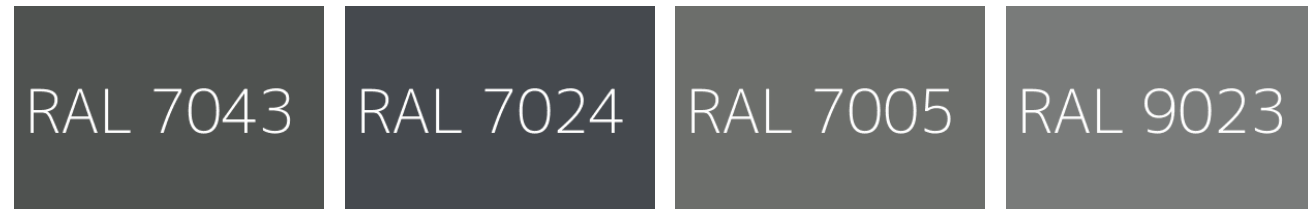

GREENS

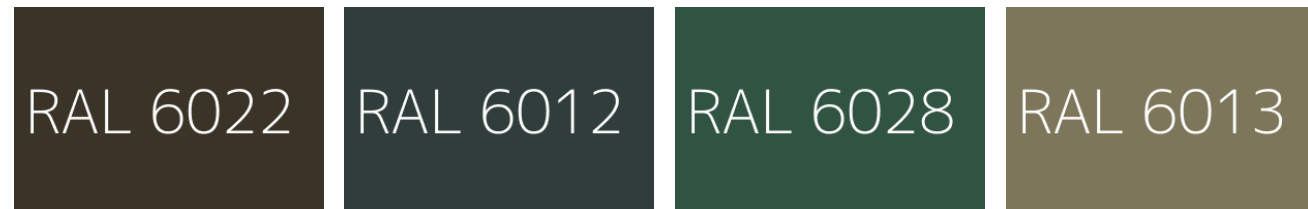

NOVISTA STEEL RISERS

FRAME

Concealed/Picture frame design made from 1.2mm steel. 3 or 4 sided frame options

LEAF

Double skin 1.0mm Zintec Steel with glass wool insulated core. 48mm thick

CONFIGURATIONS

Single leaf, double leaf and up to six leaves within one frame

PERFORMANCE

- Fire Rating - FD120(S)
- Acoustic Rating - 41dB Rw (as standard)
- Smoke/Air tested - To BS6375-1, BSEN1634-3 and to BSEN13501-2
- Thermal Resistance - 1.43(m²K)/W

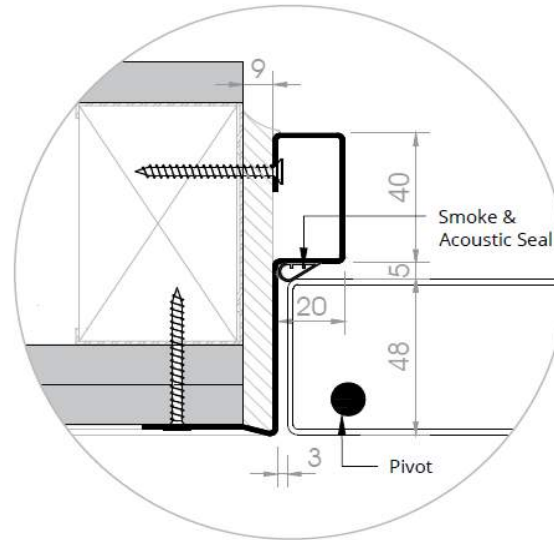

FLIP LOCK OPTION

NOVISTA RISER STEEL

CONCEALED LOCK OPTION

Flip lock hides chosen lock mechanism behind a flush hinged pocket.

FD60 fire rated and bi-directionally tested

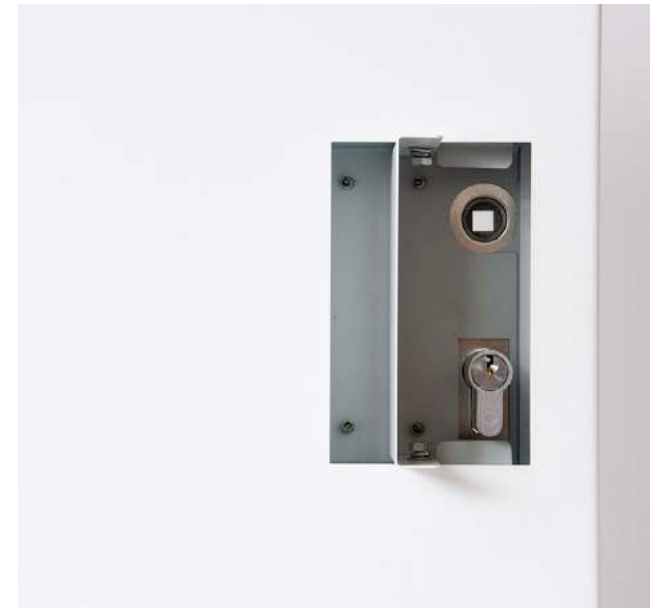
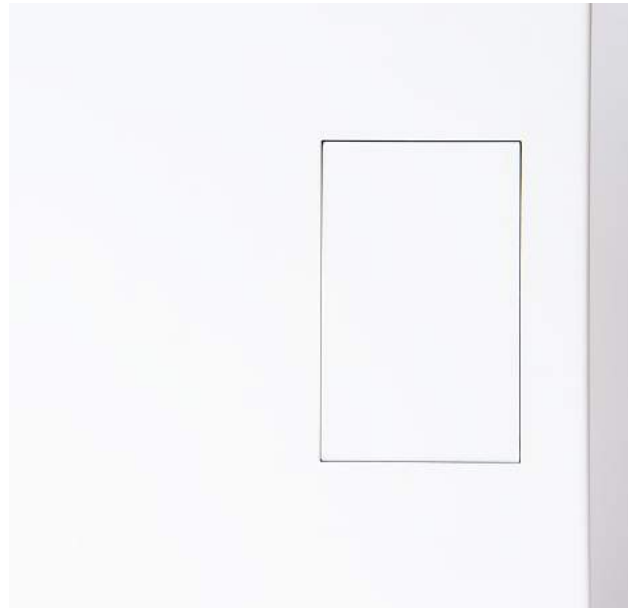

IRONMONGERY

EXCELLENT RANGE

Ultimate solution of architectural ironmongery from...

- ✓ Lever handles
- ✓ Pull handles
- ✓ Escutcheons
- ✓ Turns and releases
- ✓ Hinges
- ✓ Signage
- ✓ Locks & cylinders
- ✓ Door closers
- ✓ Panic Hardware
- ✓ Miscellaneous

Range of finishes...

- ✓ Stainless Steel
- ✓ Satin Stainless Steel
- ✓ Satin Chrome
- ✓ Polished Chrome
- ✓ PVD Bronze

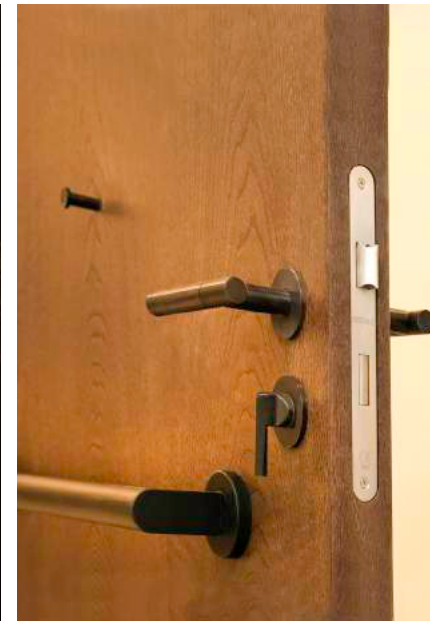

IRONMONGERY

POPULAR CHOICES

LEVER HANDLES

Manufactured from stainless steel
Sprung rose through fixed rose
Spindle fast fixing system prevents levers
from pulling off the doors
Concealed fixings to prevent illegal tampering
Lever fixed to metal inner rose



CONCEALED DOOR CLOSER

A high efficiency, true cam action concealed slide
arm closer. CE marked against EN1154
Included in successful fire test to EN1634
Suitable for use on timber fire doors



DOOR STOP

60031 floor fixed door stop with threaded location
bolt and rubber buffer. Location bolt extends 15mm
into the floor providing very secure fixing
Available in satin/polished stainless steel or
satin anodised aluminium



DOOR STOP

Heavy duty floor mounted door stop.
Concealed fix. Stainless steel material.
Supplied with fixings

IRONMONGERY

POPULAR CHOICES

T BAR PULL HANDLE

Bolt through fixed with M8 machine screws
Suitable for doors up to 54mm thick
Available in satin or polished stainless steel
Dimensions comply with the requirements of
BS8300 and Approved Document M

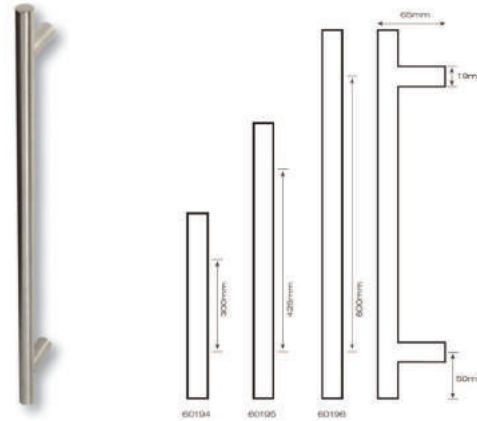

KICK PLATE

Plates of any size can be manufactured
Available in satin/polished stainless steel
or satin anodised aluminium



FIRE SIGNAGE

Available in satin/polished
stainless steel or satin anodised aluminium
Drilled & countersunk for screw fixings
Screen printed



Ælement

SALTO SOLUTION

A hotel experience you need to discover. The minimalistic design of the RFID reader looks stylish and discreet on any door. It also offers the choice of a wide range of designer lever handles and finishes

Reader body made using double layered injection construction

Clear dual colour LED light (green/red) to indicate lock authorisation

Special blink and beep indication when lock is in privacy mode

Ability to enable/disable the acoustic signal

Covers door thicknesses: From 35mm to 125mm





Let's work on specifications
together, find us on...



NBS Chorus



NBS Source
PARTNER

FREE SAMPLES

Request for door leave samples & ironmongery sample board
to see how well we can match your project requirements.
Simply email sales@aspex.co.uk

GET IN TOUCH

www.aspex.co.uk | info@aspex.co.uk
England office: 0116 278 3506
Scotland office: 01236 720061

aspex